

**A PROJECT REPORT
ON
“FABRICATION, INSTALLATION AND TESTING OF NCES”**

Submitted by

ANSARI MAAZ	14DME124
SHAIKH SHAMNAN	13ME51
SONAL SALUNKHE	13ME02
POOJA WADKAR	13ME03

In partial fulfillment for the award of the Degree

Of

BACHELOR OF ENGINEERING

IN

MECHANICAL ENGINEERING

UNDER THE GUIDANCE

Of

PROF. NAWAZ MOTIWALA



DEPARTMENT OF MECHANICAL ENGINEERING

ANJUMAN-I-ISLAM's

KALSEKAR TECHNICAL CAMPUS NEW PANVEL,

NAVI MUMBAI – 410206

UNIVERSITY OF MUMBAI

ACADEMIC YEAR 2016-2017



ANJUMAN-I-ISLAM's
KALSEKAR TECHNICAL CAMPUS NEW PANVEL
(Approved by AICTE, reg. By Maharashtra Govt. DTE,
Affiliated to Mumbai University)

PLOT #2&3, SECTOR 16, NEAR THANA NAKA, KHANDAGAON, NEW PANVEL, NAVI MUMBAI-410206, Tel.: +91 22 27481247/48 * Website: www.aiktc.org

CERTIFICATE

This is to certify that the project entitled
“FABRICATION,INSTALLATION AND TESTING OF NCES”

Submitted by

ANSARI MAAZ	14DME124
SHAIKH SHAMNAN	13ME51
SONAL SALUNKHE	13ME02
POOJA WADKAR	13ME03

To the Kalsekar Technical Campus, New Panvel is a record of bonafide work carried out by him under our supervision and guidance, for partial fulfillment of the requirements for the award of the Degree of Bachelor of Engineering in Mechanical Engineering as prescribed by **University Of Mumbai**, is approved.

Project co-guide

(Prof. Nawaz Motiwala)

Internal Examiner

(Prof._____)

External Examiner

Head of Department

(Prof. Zakir Ansari)

Principal

(Dr.Abdul Razak Honnutagi)



ANJUMAN-I-ISLAM'S
KALSEKAR TECHNICAL CAMPUS NEW PANVEL
(Approved by AICTE, reg. By Maharashtra Govt. DTE,
Affiliated to Mumbai University)

PLOT #2&3, SECTOR 16, NEAR THANA NAKA, KHANDAGAON, NEW PANVEL, NAVI MUMBAI-
410206, Tel.: +91 22 27481247/48 * Website: www.aiktc.org

APPROVAL OF DISSERTATION

This is to certify that the thesis entitled
“FABRICATION, INSTALLATION AND TESTING OF NCES”

Submitted by

ANSARI MAAZ	14DME124
SHAIKH SHAMNAN	13ME51
SONAL SALUNKHE	13ME02
POOJA WADKAR	13ME03

In partial fulfillment of the requirements for the award of the Degree of Bachelor of
Engineering in Mechanical Engineering, as prescribed by University of Mumbai approved.

(Internal Examiner)

(External Examiner)

Date: _____

ACKNOWLEDGEMENT

After the completion of this work, we would like to give our sincere thanks to all those who helped us to reach our goal. It's a great pleasure and moment of immense satisfaction for us to express my profound gratitude to our guide **Prof. Nawaz Motiwala** whose constant encouragement enabled us to work enthusiastically. His perpetual motivation, patience and excellent expertise in discussion during progress of the project work have benefited us to an extent, which is beyond expression.

We would also like to give our sincere thanks to **Prof. Zakir Ansari**, Head Of Department, **Prof. Nawaz Motiwala**, Project Co-Guide and **Prof. Rizwan Shaikh**, Project coordinator from Department of Mechanical Engineering, Kalsekar Technical Campus, New Panvel, for their guidance, encouragement and support during a project.

I am thankful to **Dr. Abdul Razak Honnutagi**, Kalsekar Technical Campus New Panvel, for providing an outstanding academic environment, also for providing the adequate facilities.

Last but not the least I would also like to thank all the staffs of Kalsekar Technical Campus (Mechanical Engineering Department) for their valuable guidance with their interest and valuable suggestions brightened us.

ANSARI MAAZ	14DME124
SHAIKH SHAMNAN	13ME51
SONAL SALUNKHE	13ME02
POOJA WADKAR	13ME03

ABSTRACT

Energy is the prime source of all socio-economic activities of the human community.. There is an impending need to make much more forays to make Non-Conventional energy attain popular acclaim. This is also very essential to preserve the conventional sources of energy and explore viable alternatives like sustainable energy (the energy which we are already utilizing but for some safety of other uses we are suddenly wasting it, that can be reutilized), solar, wind and hydro that can enhance sustainable growth. Our objectives are to support efforts for developing, demonstrating and commercializing new and emerging technologies in the RE sector, and to this end, help establish linkages with national and international institutions for active collaboration, to establish dedicated renewable energy “Special Economic Zones” (SEZ) to promote renewable energy projects. With this project we can save economy per month & the cost required for this project can be payback in 5.95 years and after that it will be free with negligible maintenance cost and eco-friendly for environment.

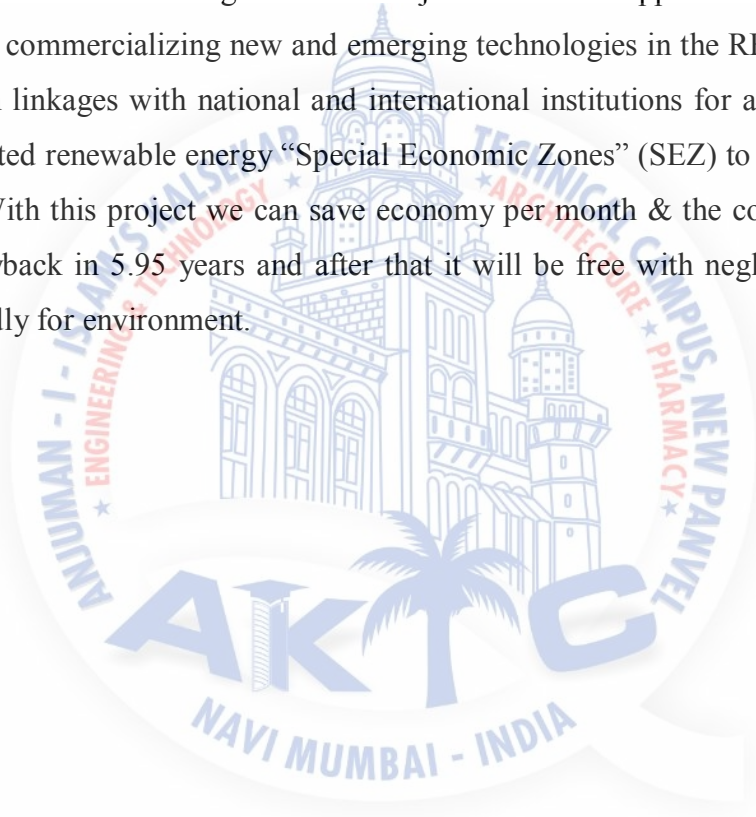

TABLE OF CONTENT

ABSTRACT	I
LIST OF TABLE	IV
LIST OF FIGURES	V
1. Introduction	1
1.1 Background	2
1.2 Indian Energy Scenario	4
1.3 Aiming Big	7
1.4 Issue in Implementation	8
1.5 Possible solutions of the Energy Crisis	9
2. Review of Literature	11
3. Methodology	15
3.1 Solar power system	16
3.2 Wind power system	17
3.3 Hydro power system	19
4. Design and Calculation	21
4.1 Structural Design Method	22
4.2 Solar System	23
4.3 Wind Turbine	27
4.4 Hydro Turbine	30
4.5 M. S. Angle Tower	34
4.6 Analysis of Pelton bucket	35
5. Fabrication	39
5.1 Material Selection	40
5.2 Machining of parts	42
5.3 Actual Setup	50

6. Cost Estimation	53
6.1 Purpose of Cost Estimation	54
6.2 Type of Budget Estimation	54
6.3 Material Cost	55
6.4 Labor Cost	55
7. Result and Discussion	59
8. Paper published	61
9. Conclusion	63
10. Future Scope	65
Appendix	67
References	71



LIST OF TABLES

No	Title	Page no.
4.1	Components & its Specification for calculation	25
4.2	Stainless Steel Properties	36
4.3	Deformation at different Pressure	38
4.4	Stress at different Pressure	38
5.1	Process for manufacturing of Frame	46
5.2	Process of manufacturing of Blade	47
5.3	Process of manufacturing of Shaft	48
5.4	Process of manufacturing of Pelton Buckets	49
6.1	Material Cost	55
6.2	Direct cost	56



LIST OF FIGURES

No	Title	Page no.
1.1	Illustration of Global Renewable Energy Usage	6
1.2	Biogas Plants & Waste Management Systems	8
2.1	Illustration of the vertical axis wind turbine	14
3.1	Methodology for Solar Power System	16
3.2	Methodology for Wind Power System	18
3.3	Methodology for Hydro Power System	19
4.1	Solar Panel	23
4.2	Charge controller	23
4.3	Power Inverter	24
4.4	Battery	24
4.5	Software Model of Wind Turbine	27
4.6	PVC Pipe	27
4.7	Tin sheet deflector	28
4.8	Horizontal Blades	28
4.9	Curved Blade Air Flow and Performance	29
4.10	Pelton Wheel	30
4.11	Buckets & Runner	30
4.12	Nozzle	31
4.13	Casing For Hydro Turbine	32
4.14	M.S angle tower	34
4.15	Pelton Bucket	35
4.16	Mesh View	36
4.17	Mesh details	36
4.18	Pressure Applied	37
4.19	Constraint and Fixed	37
4.20	Equivalent Stress & Strain	37
4.21	Deformation	38
5.1	Hacksaw Machine	43
5.2	Lathe Machine	43

5.3	Drill Machine	44
5.4	Grinding Machine	45
5.5	Bench Grinding Machine	45
5.6	Measuring Tape	45
5.7	Vernier Caliper	45
5.8	Measuring scale	45
5.9	L angle	46
5.10	Marking and cutting of angle	46
5.11	Welding of chassis	47
5.12	Chassis	47
5.13	Blades Manufacturing	48
5.14	Turning	49
5.15	Shaft and Flange	49
5.16	Actual Pelton Wheel turbine	50
5.17	Actual Pelton Bucket	50
5.18	Actual set of Hydro Turbine	50
5.19	Actual setup of Wind Turbines	51
5.20	Actual setup of Solar System	52
5.21	Actual setup of Combined System	52

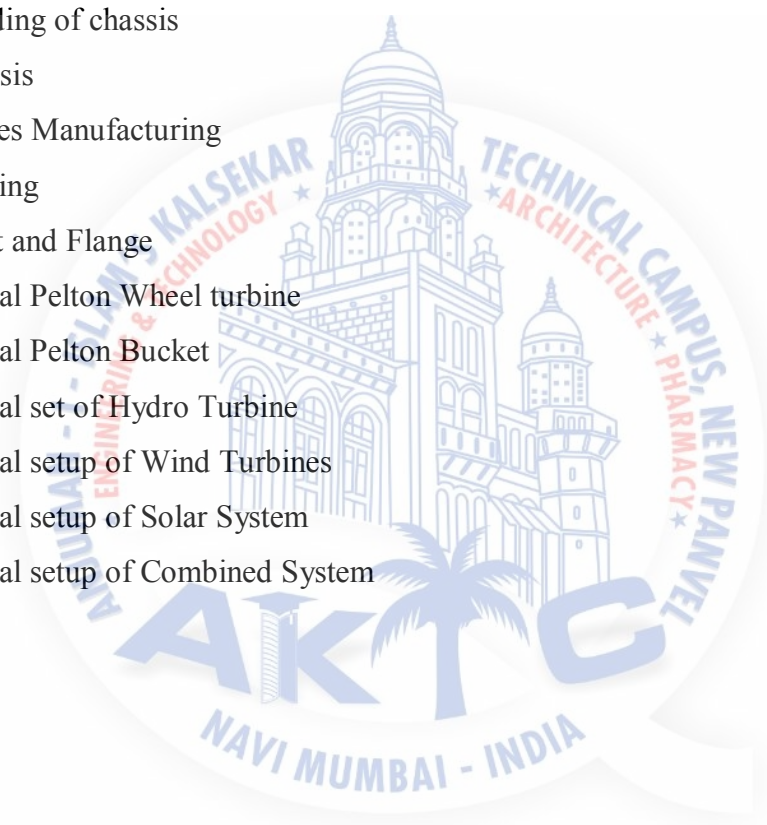

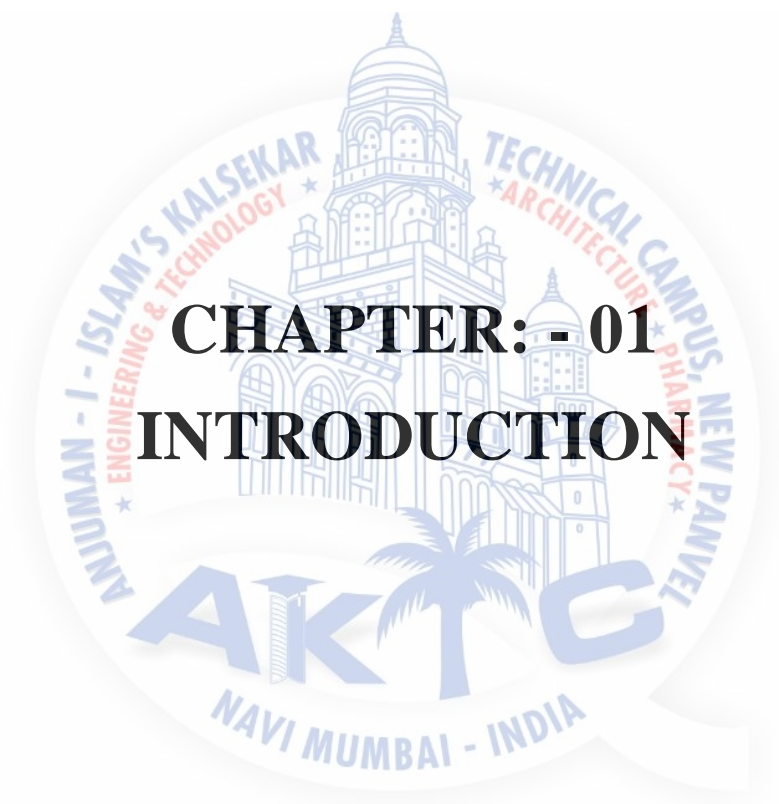

CHAPTER: - 01

INTRODUCTION

1. INTRODUCTION

1.1 BACKGROUND

Renewable energy is energy that is collected from renewable resources, which are naturally replenished on a human timescale, such as sunlight, wind, rain, tides, waves, and geothermal heat. Renewable energy often provides energy in four important areas: electricity generation, air and water heating/cooling, transportation, and rural (off-grid) energy services.

Renewable energy resources exist over wide geographical areas, in contrast to other energy sources, which are concentrated in a limited number of countries. Rapid deployment of renewable energy and energy efficiency is resulting in significant energy security, climate change mitigation, and economic benefits. The results of a recent review of the literature concluded that as greenhouse gas (GHG) emitters begin to be held liable for damages resulting from GHG emissions resulting in climate change, a high value for liability mitigation would provide powerful incentives for deployment of renewable energy technologies. In international public opinion surveys there is strong support for promoting renewable sources such as solar power and wind power. At the national level, at least 30 nations around the world already have renewable energy contributing more than 20 percent of energy supply. National renewable energy markets are projected to continue to grow strongly in the coming decade and beyond. Some places and at least two countries, Iceland and Norway generate all their electricity using renewable energy already, and many other countries have the set a goal to reach 100% renewable energy in the future. For example, in Denmark the government decided to switch the total energy supply (electricity, mobility and heating/cooling) to 100% renewable energy by 2050.

While many renewable energy projects are large-scale, renewable technologies are also suited to rural and remote areas and developing countries, where energy is often crucial in human development. As most of renewable provide electricity, renewable energy deployment is often applied in conjunction with further electrification, which has several benefits: Electricity can be converted to heat (where necessary generating higher temperatures than fossil fuels), can be converted into mechanical energy with high efficiency and is clean at the point of consumption. In addition to that electrification with renewable energy is much more efficient and therefore leads to a significant reduction in primary energy requirements, because most renewables don't have a steam cycle with high losses (fossil power plants usually have losses of 40 to 65%).

Renewable energy systems are rapidly becoming more efficient and cheaper. Their share of total energy consumption is increasing. Growth in consumption of coal and oil could end by 2020 due to increased uptake of renewables and natural gas.

1.1.1 Form Of Non Conventional Energy Source

There are many form of renewable energy available in nature,

- **Solar Energy:**

The sun provides us enormous amounts of energy in the form of solar radiation — energy that travels in small wave packets called photons, reaching the surface of the Earth from a distance of 150 million kms (93 million miles) in only 8 minutes. Solar energy can be used in production of heat, electricity, bio-energy etc.

- **Hydro Energy:**

Hydropower plants convert the energy of flowing water into electricity. This is primarily done by damming rivers to create large reservoirs and then releasing water through turbines to produce electricity. Hydropower results in no emissions into the atmosphere but the process of damming a river can create significant ecological problems for water quality and for fish and wildlife habitat.

- **Bio-Energy:**

Includes those processes where biological forms of matter such as plants, vegetables, bacteria, enzymes etc. provide the basis for energy or its conversion from one form to another. The widest use of bio-energy is the traditional way where wood plants and agricultural matters are burnt to provide heat. Bio-mass includes both terrestrial as well as aquatic matter and can be grouped into new plant growth, residues and wastes.

- **Wind Energy:**

Is the kinetic energy associated with movement of large masses of air resulting from differential heating of the atmosphere by the sun. Wind energy is renewable and poses no major environmental threats. Small windmills with direct mechanical drive matched to a pump and tank storage are in extensive use in many parts of the world.

Some new all-metal multi-bladed windmill designs have been developed; like the traditional multi-bladed windmills, they have a good starting torque, but lighter in weight, are simpler to fabricate and have slightly better efficiencies.

- Ocean Energy:

The sea which is constantly receiving solar radiations and acts as the world's largest natural solar collector has potential to provide a means of utilizing renewable energy. It acts not only as a collector but also has an enormous storage capacity. Energy from ocean is available in several forms such as ocean thermal energy, wave, tidal, Salinity gradient, ocean current, ocean wind and bio-mass

- Geothermal energy:

The geothermal energy may be defined as the heat energy obtainable from hot rocks present inside the earth crust. At the deeper region of earth crust, the solid rock gets melted in to magma, due to very high temperature. The magma layer is pushed up due to some geological changes and get concentrated below the earth crust. The places of hot magma concentration at fairly less depth are known as hot spots.

These hot spots are known as sources of geothermal energy. Now a days, efforts are being made to use this energy for generating power and creating refrigeration etc. There are a quite few number of methods of harnessing geothermal energy. Different sites of geothermal energy generation are Puga (Ladakh), Tattapani (Suraguja, M.P.), Cambay Basin (Alkananda Valley, Uttaranchal).[1]

1.2 INDIAN ENERGY SCENARIO

- Commercial sources of Energy (sources that cost i.e. coal, petroleum, electricity) are only 50% of total energy consumption in India. Means non-commercial sources like fuelwood, agricultural waste & animal dung constitute ½ of the total energy consumption in India.
- More than 60% of Indian households depend on traditional sources of Energy for cooking & heating needs.
- At current rate of consumption & production, coal reserves in India would last for about 130 years.

- In commercial energy consumption, coal constitutes 29%, Oil & gas 54% & electricity 17%.
- We are using only 20% of total hydro-power potential. (Estimated annual energy potential from hydro-electric sources is around 90000 MW while we are currently producing 18000 MW.
- Out of total electricity production, 65.8% comes from thermal power plants, 26.3% from hydro electricity & only 3.1% from nuclear power. Non-conventional, renewable energy sources like solar, wind energy constitute nearly 4.9%. (As per NIC site on Ministry of Power).
- Public sector produces 558 billion kwh of electricity while private sector only 58 billion kwh.
- Uranium reserves in country – 70,000 tonnes (equivalent to 120 billion tonnes of coal) and Thorium reserves – 3,60,000 tonnes (equivalent to 600 billion tonnes of coal) – which is about 5 times the coal reserves in country.
- 65% of total rural energy consumption is met from fuel woods– (180 million tonnes for households + 43 million tonnes for cottage industry, hotels etc). At this rate, in near future, fuelwood could be a greater constraint than availability of foodgrains. (The problem can be solved by government spending of around Rs. 1000 crore annually).
- If animal dung is not utilized for burning and is used as fertilizer, food production would increase considerably because 73 million tonnes of animal dung is burnt every year for energy purposes, which is far more than total fertilizer consumed in agriculture production in India.
- From 1951 to 2004, the coal production has increased 12 times, crude oil 110 times & electricity 65 times.
- In 1973, price for petroleum crude oil in global market was only \$2 per barrel (\$2.09 exactly).
- Did you know, India has not experienced a sudden shock in its balance of payments after steep increase in global oil prices thanks to large inward remittance of foreign currencies by Indians working abroad.
- Only 0.3% of world's known oil reserves are in India.
- Transport sector accounts for 56% of total oil consumption in India.
- Millions of poor people in India spend up to 100 man-days every year in gathering fuel wood for cooking purposes.
- Demand for coal rises @ 4 to 5% per year, for petroleum products 6 to 7% per year & for electricity 9 to 10% per year.

- India is second largest exploiter of Wind Energy – 1000 MW (70% by private sector). There are 33 lakh bio-gas plants, 2 lakh solar cookers & 10000 street lighting systems using solar photo-voltaic technology.
- Out of total electricity consumption in India, 34% goes to Industry, 24% to agriculture, 21% to domestic use, 12% to public lighting & 2% to railway traction. These figures do not include captive (i.e. private sector) power generation.
- Currently 5,87,560 villages in India have electricity. Still 1,12,400 villages haven't seen what electricity is! (most of these are in Assam, Orissa, UP, MP & Rajasthan).

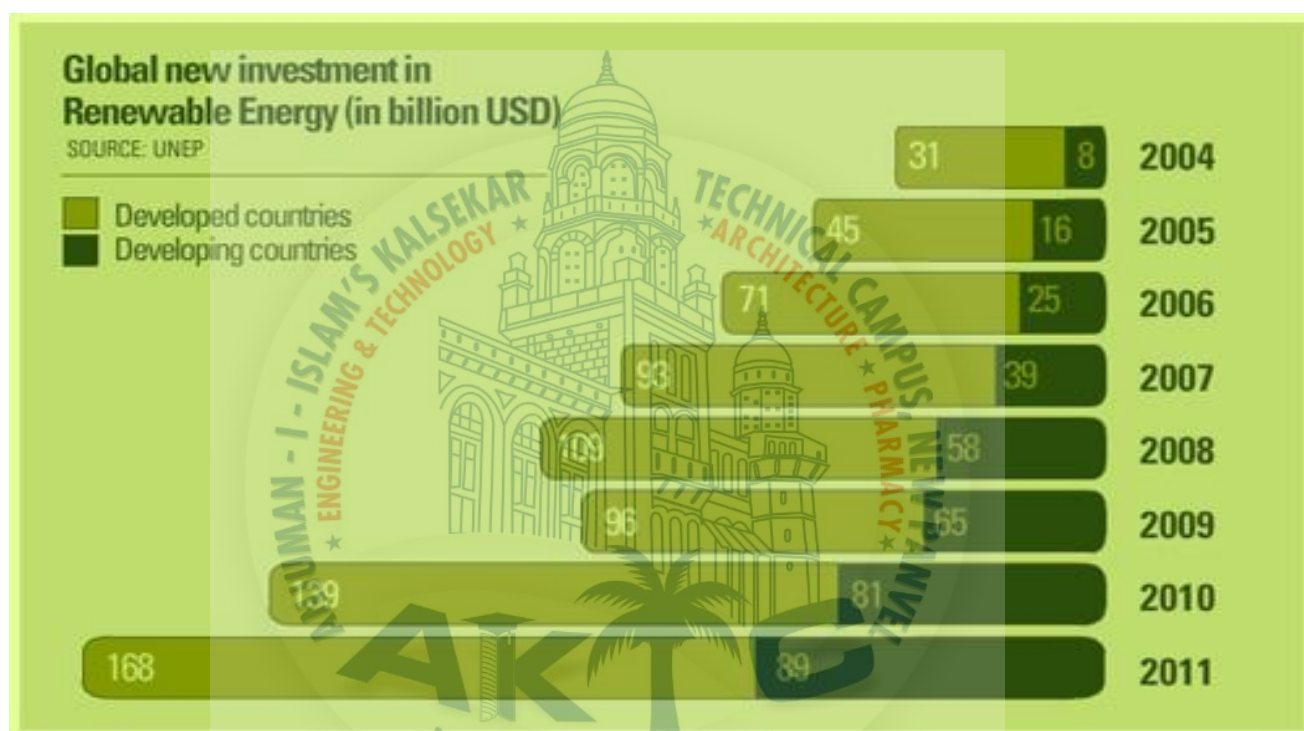

Fig.1.1 Illustration of Global Renewable Energy Usage^[2]

- And that does not mean that every house in those 5,87,560 electrified villages has electricity, even if 10% of the households get electricity, government declares the village electrified! (This is as per 'new modified' definition of 'electrified villages' formulated in 2003-04.)
- India is the fifth largest consumer of energy in the world, and will be the third largest by 2030[3],[4]

1.2.1 Why Non-Conventional Energy?

In 2013-14, peak power shortage of India was around seven percent and electricity demand is expected to rise by 7.4 per cent a year during the next quarter of a century. Unfortunately, India cannot realistically expect to bridge this power deficit by increasing reliance and dependence on the fossil fuels.

The reason for the same are many, ranging from socio-economic to environmental and health issues. According to Energy Statistics 2012, India imports about 75 percent of its oil which in fact comprises one- third of its total imports. Similarly, India's coal imports are likely to touch a whopping 185 million tonnes by 2017. Hence, the Indian government has been also making serious efforts to enhance India renewable energy production since recent past.[5]

A major advantage of renewable energy is that it can be regenerated and is therefore sustainable as it will never run out. It has several advantages over its hydrocarbon based alternatives and provides substantial benefits for our climate, our health and our economy. Some of the important benefits of renewable energy are, little to be no global warming emissions, improved public health and environmental quality, a vast and inexhaustible energy supply, stable energy prices and a more reliable and resilient energy system.

1.3 AIMING BIG

India is one of the fastest growing countries in terms of energy consumption. Currently, it is the fifth largest consumer of energy in the world, and will be the third largest by 2030. At the same time, the country is heavily dependent on fossil sources of energy for most of its demand, thus necessitating to aggressively pursue alternative energy sources such as solar, wind, biofuels, small hydro, geothermal and others. The country has an estimated renewable energy potential of around 85,000 MW from commercially exploitable sources: wind: 45,000 MW, small hydro: 15,000 MW and biomass/bioenergy: 25,000 MW. In addition, India has the potential to generate 35 MW per square km using solar photovoltaic and solar thermal energy.

It has proposed an addition of 15,000 MW of Renewable Energy generation capacities during the period. Of this proposed capacity addition, wind power projects are expected to pitch in about 70 percent (10,500 MW) while Small Hydro Projects (SHP) would accounts for 9.3 percent (1,400 MW).[5]

1.4 ISSUES IN IMPLEMENTATION

While there is no denying that nonconventional power is a boon, there are some practical implementation issues which often trouble investors. These range from physical damage to installed equipment's to environmental issues. For instance, wind turbines can be hazardous to flying birds, while hydroelectric dams can create barriers for migrating fish, in addition to displacement of human habitations. Burning biomass and bio-fuels causes air pollution similar to that of burning fossil fuels, although it causes a lower greenhouse effect since the carbon placed in the atmosphere was already there before the plants were grown. [5]

1.4.1 Biogas Plants & Waste Management Systems

Another issue to consider is of evacuation infrastructure. Just like conventional sources of power, significant non-conventional power generation resources are often located at large distance from the major population centers where electricity demand exists. Exploiting such resources on a large scale inevitably requires considerable investment in transmission and distribution networks as well as in the technology itself.



Fig.1.2 Biogas Plants & Waste Management Systems^[5]

Furthermore, power generations from renewable sources are very often intermittent in nature. Solar energy, for example can only be expected to be available during the day (50 percent of the time). Wind energy intensity varies from place to place and somewhat from season to season. Constant stream of water is often not available throughout the year for generating optimum Hydro power. This requires a substantial investment in storage capacity which adds to the overall cost of generating power.

When seen in light of massive and sustained energy deficit and the grid failure which led to the world's largest power outage a couple years ago, which affected 700 million people, India needs a drastic overhaul of its energy sector. The unreliable supply of electricity, depleting natural resource and irreparable environmental degradation have become big challenges to sustainable development of the country, economically and socially.

India's tremendous energy needs cannot be met solely with conventional method of electricity generation. To overcome this problems and to meet the future energy demands, India must go towards harnessing huge potential of non-conventional source of energy. It has several advantages including decentralization of energy particularly for meeting rural energy needs, and thereby empowering rural people at the grass roots level.

Like any other source, nonconventional energy has got some associated issue which need to be resolved before aggressive deployment of electricity production from these sources can take place. The exact type and intensity of environmental impacts varies depending on the specific technology adopted, the geographic location, and other operational factors. Thus, we must stress upon research and development not only to understand the current and potential environmental issues associated with each renewable energy source but also to develop cleaner technologies. It will help achieving the national security and economic goal on the one hand and will provide enormous environmental benefits and combat climate change on the other.

1.5 POSSIBLE SOLUTIONS OF THE ENERGY CRISIS

Many of the possible solutions are already in place today, but they have not been widely adopted.

1. Move Towards Renewable Resources: The best possible solution is to reduce the world's dependence on non-renewable resources and to improve overall conservation efforts. Much of the industrial age was created using fossil fuels, but there is also known technology that uses other types of renewable energies – such as steam, solar and wind. The major concern isn't so much that we will run out of gas or oil, but that the use of coal is going to continue to pollute the atmosphere and destroy other natural resources in the process of mining the coal that it has to be replaced as an energy source. This isn't easy as many of the leading industries use coal, not gas or oil, as their primary source of power for manufacturing.

2. Buy Energy Efficient products: Replace traditional bulbs with CFL's and LED's. They use less watts of electricity and last longer. If millions of people across the globe use LED's and CFL's for residential and commercial purposes, the demand for energy can go down and an energy crisis can be averted.

3. Lighting Controls: There are a number of new technologies out there that make lighting controls that much more interesting and they help to save a lot of energy and cash in the long run. Preset lighting controls, slide lighting, touch dimmers, integrated lighting controls are few of the lighting controls that can help to conserve energy and reduce overall lighting costs.

4. Easier Grid Access: People who use different options to generate power must be given permission to plug into the grid and getting credit for power you feed into it. The hassles of getting credit of supplying surplus power back into the grid should be removed. Apart from that, subsidy on solar panels should be given to encourage more people to explore renewable options.

5. Energy Simulation: Energy simulation software can be used by big corporates and corporations to redesign building unit and reduce running business energy cost. Engineers, architects and designers could use this design to come with most energy efficient building and reduce carbon footprint.

6. Perform Energy Audit: Energy audit is a process that helps you to identify the areas where your home or office is losing energy and what steps you can take to improve energy efficiency. Energy audit when done by a professional can help you to reduce your carbon footprint, save energy and money and avoid energy crisis.

7. Common Stand on Climate Change: Both developed and developing countries should adopt a common stand on climate change. They should focus on reducing greenhouse gas emissions through an effective cross border mechanism. With current population growth and over consumption of resources, the consequences of global warming and climate change cannot be ruled out. Both developed and developing countries must focus on emissions cuts to cut their emission levels to half from current levels by 2050.[6]

The logo of AIKTC (All India Kisan Technical College) is circular and features a central illustration of a grand building with a dome and arches. The text around the logo includes "ISLAM - I - ISLAM'S KALSEKAR ENGINEERING & TECHNOLOGY" on the left, "TECHNICAL CAMPUS, NEW PATEL ARCHITECTURE PHARMACY" on the right, and "NAVI MUMBAI - INDIA" at the bottom. The acronym "AIKTC" is prominently displayed in the center of the logo.

CHAPTER: - 02

REVIEW OF LITERATURE

2. REVIEW OF LITERATURE

Till now many researchers have carried out about the Non-conventional energy sources and their effective use. The various experiments have done on Solar, Wind and Hydro power plant, design of blade of wind turbine, bucket design etc. The papers which deal with the present study of interest are discussed below.

K .S. Sindhu [7] presented the non-conventional energy sources and their usage in India with a case study of Punjab state. In developing countries, where a lot of energy production capacity is to be added, the rapid increase in renewable is in principle easier than in the industrial countries where existing capacity would need to be converted if rapid changes were to take place. India must give more thrust on to research and development in the field of non conventional energy sources not only to mitigate greenhouse effect but also to lessen dependent on oil/gas import which consumes major chunk of foreign exchange reserve.

Mostefa Ghassoul [8] gave the information of tracking sun's position by microcontroller it maximizes the solar cell output by positioning the solar panel. The system can also align itself to perfection either on sunrise or sunset so no drift is could occur.

C.S. Ferekides [9] analysed that World need 20TW of non-CO₂ energy to stabilize CO₂ in atmosphere. At present, the PV market is growing rapidly at an annual rate of 35–40%, with PV production around 10.66 GW in 2009. Si and GaAs monocrystalline solar cell efficiencies are very close to the theoretically predicted maximum values. Mono- and polycrystalline wafer Si solar cells remain the predominant PV technology with module production cost around \$1.50 per peak watt. Thin-film PV was developed as a means of substantially reducing the cost of solar cells.

D. W. & Michael [10] and Ashish S. Ingole[11] described hybrid power system consisting of PV-arrays and wind turbines with energy storing devices (battery bank) The integration of the hybrid is to electrify a residential house and its surrounding in order to reduce the need for fossil fuel leading to an increase in the sustainability of the power supply. This approach is techno-economically viable for rural electrification. The efficiency of the designed electricity generating machine (inverter) is about 95% and 73% for capacitive and resistive loads respectively. The wind turbine performance showed a promising output, but there was a challenge with the generator at lower wind speed only 0.77V was added to the battery's state of charge.

N.Sivaramakrishna[12] also described an alternative energy harvesting approach based on Nano-antennas that absorb the incident solar radiation .The Nano-antennas target mid-infrared rays, which the Earth continuously radiates as heat after absorbing energy from the sun during the day. In contrast, traditional solar cells can only use visible light, rendering them idle after dark. Infrared radiation is an especially rich energy source because it is also generated by industrial processes such as thermal plants. This Integration of renewal Energy source will be highly effective in all places, especially in commercial areas where need of electricity is more.

Ashok Upadhyay[13] gave the details of an overview of technical, economic and policy aspects of solar energy development. It reviews the status of solar energy in terms of resource potential, existing capacity, along with historical trends and future growth prospects of solar energy. Solar power is infirm power and efforts are required to be made it firm power by developing appropriate storage facilities. The solar power can also make a viable source of energy by announcing the suitable policies incentives. Re-powering has to be a part of any strategy to scale-up solar power capacity as it is vital to optimally utilize high solar radiation sites that remain unused due to less effort by the government and investing companies and to retrofit or replace the old panels with modern, large and higher, more efficient ones.

Altab Hossain[14] has studied an adaptive Neuro-fuzzy inference system (ANFIS) is proposed to predict wind power generation. He has demonstrated the viability of the developed ANFIS model to evaluate power generation in wind turbine within high accuracy without needing to undergoing laborious experimental work for a variety of environmental conditions with many uncertainties which can be non economical and time consuming.



Fig.2.1 Illustration of the vertical axis wind turbine used to measure the power generation^[14]

Pinnanti Sravanthi[15] has briefly described design and analysis of Pelton Wheel Bucket. Its newly develop design modeling and analysis on software. the traditional and advanced buckets have been simulated in SOLIDWORKS simulation tool, Two different materials such as 1060 alloy and 1020 steel have been applied to traditional and advanced bucket under given loading conditions 269N and 10000N. Even though they on misses' stresses values are almost equal for both traditional and advanced bucket of both the materials. The displacement has been optimal for advanced bucket of pelton wheel. So the best suitable material among the two is 1020 steel. The analysis carried out in this project is just one step towards optimization. There is large scope of work in this subject. Hoop optimization can be done by parametric study of hoop in which by varying the thickness of hoop it can be achieved. The fatigue analysis of pelton wheel can be done by conducting experiment Life cycle prediction of pelton wheel is also possible.

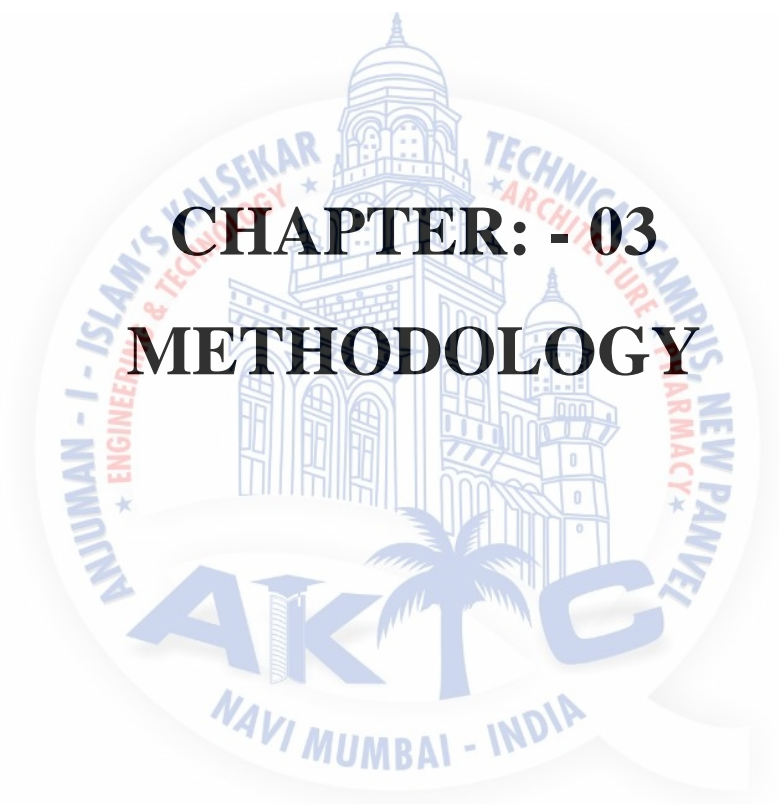

CHAPTER: - 03

METHODOLOGY

3. METHODOLOGY

3.1. SOLAR POWER SYSTEM

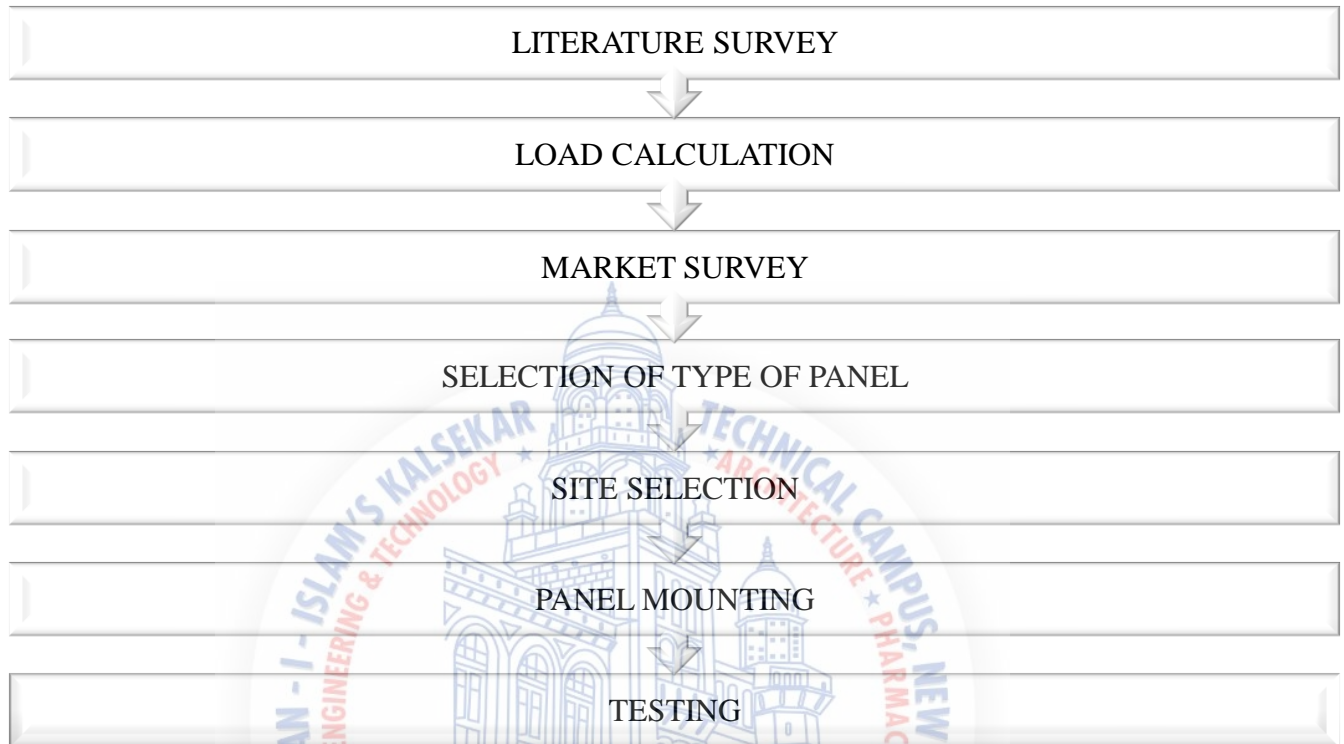

Fig.3.1 Methodology for Solar Power System

3.1.1 Literature Survey

Study the different papers, journals, books etc. to analyze the current scenario & importance of solar energy. Study the different parameters, its requirements for installing the solar setup to gain the maximum energy.

3.1.2 Load Calculation

Calculate the total connected load for which the set up is installed, its wattage capacity & number of hours for which it is working to know the required capacity of solar panel required.

3.1.3 Market Survey

As per the calculated capacity of panel, different quotation from different vendors is obtained by market survey. Select the best vendor which is economical for procurement of entire setup.

3.1.4 Election Of Type Of Panel

After studying the different types of panel, we select the best suitable panel i.e. PV type solar panel which is economical, easily available & suitable for our requirement.

3.1.5 Site Selection

By analyzing the different sites, selecting the best suitable site where intensity of solar radiation is more and remain for long period of time so that maximum output can be obtained.

3.1.6 Panel Mounting

Mount the panel on the chassis with proper mounting point provided on it and fastened it with nut bolts properly. Ensure that it is firmly fixed with chassis to avoid any damage and accident.

3.1.7 Testing

Connect all the equipment's (charge controller, battery, inverter etc.) for generation of electrical energy from solar energy and test the setup for given loads.

3.2. WIND POWER SYSTEM

3.2.1 Literature Survey

Study the different papers, journals, books etc. to analyze the current scenario & importance of wind energy. Study the different parameters, its requirements for installing the wind turbine setup for generation of electrical energy.

3.2.2 Site Selection

Analyze the different sites and select the best suitable site where we can get maximum velocity of flow of air for maximum time so that more wind energy will convert into electrical energy.

3.2.3 Selection Of Type Of Wind Turbine

By studying the different types of wind turbine, we select the automatic adjustable horizontal type of turbine which is easy to manufacture and suitable for the selected site.

3.2.4 Design

Design the wind turbine by considering the velocity of flow and determine the various parameter which is required for fabrication.

3.2.5 Selection Of Material

By studying the different materials for wind turbine, select the best material i.e. PVC which is easily available, economical and easy for machining.

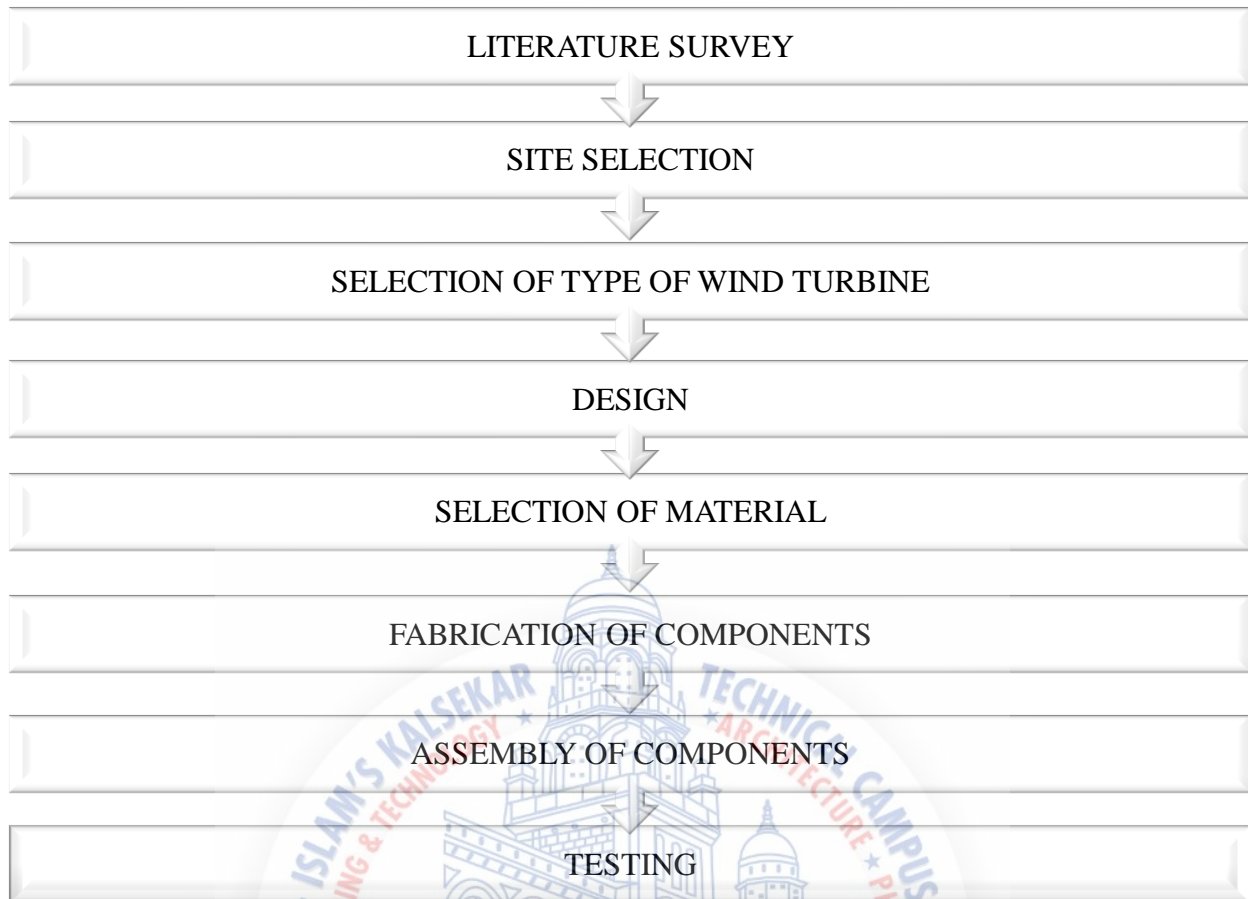

Fig.3.2 Methodology for Wind Power System

3.2.6 *Fabrication Of Components*

As per design fabricate the different components by different machining process with the accuracy of measurement.

3.2.7 *Assembly Of Components*

Assemble the different components and mount them with the frame or chassis and ensure that it is firmly fixed with it.

3.2.8 *Testing*

Connect the other accessories (generator, battery, charge controller etc.) to test the generated electrical power against the connected load.

3.3 HYDRO POWER SYSTEM

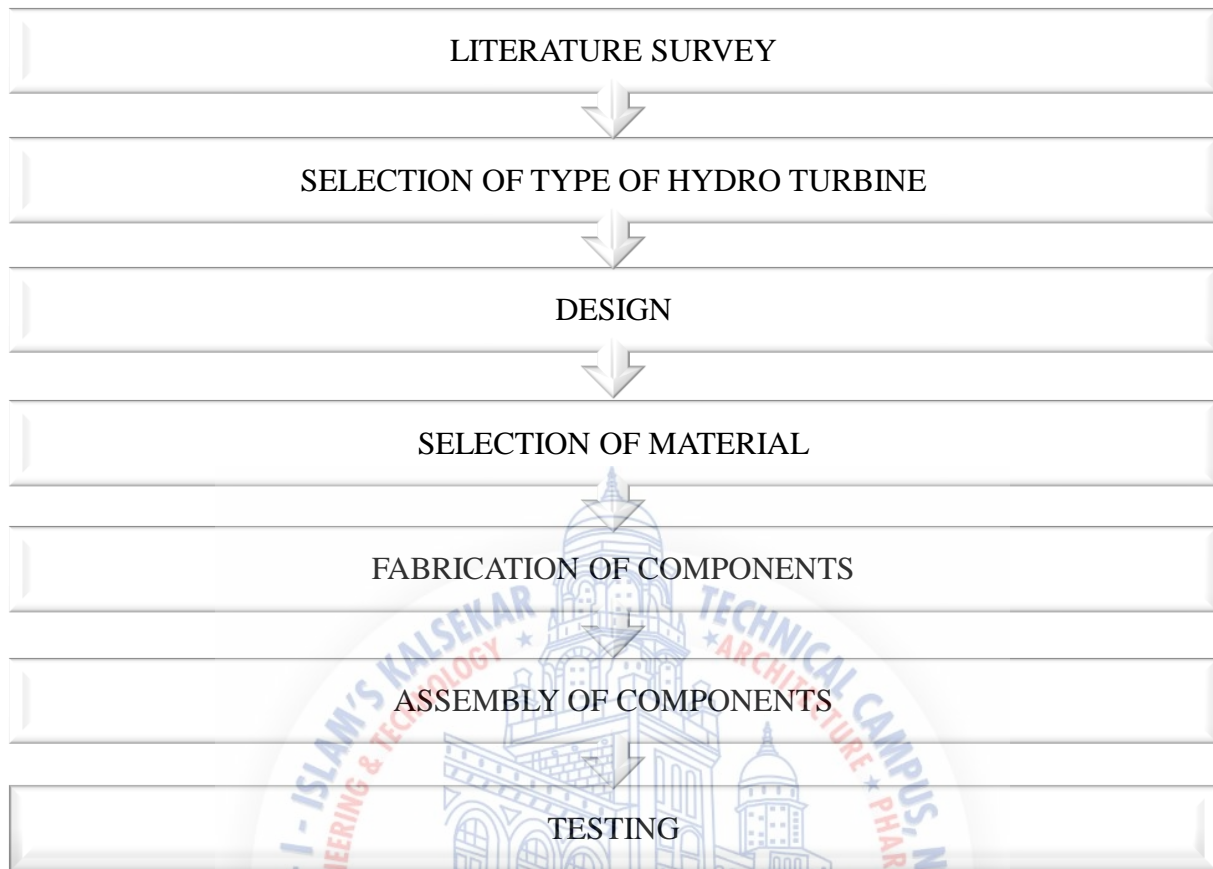

Fig.3.3 Methodology for Hydro Power System

3.3.1 Literature Survey

Study the different papers, journals, books etc. to analyze the current scenario & importance of hydro energy. Study the different parameters, its requirements for installing the hydro turbine setup for generation of electrical energy.

3.3.2 Selection Of Type Of Wind Turbine

By studying the different types of hydro turbine, we select the Pelton turbine which is easy and economical to manufacture for domestic purpose.

3.3.3 Design

Design the Pelton turbine by considering the velocity of flow and head to determine the various geometric parameters which is required for fabrication.

3.3.4 Selection Of Material

By studying the different materials for Pelton turbine, select the best material i.e. steel which is easily available, economical, corrosion resistance and easy for machining.

3.3.5 *Fabrication Of Components*

As per design, fabricate the different components by different machining process with the accuracy of measurement.

3.3.6 *Assembly Of Components*

Assemble the different components and placed them in a close casing and ensure that it is no leakage to avoid hydraulic losses.

3.3.7 *Testing*

Connect the other accessories (generator, battery, charge controller etc.) to test the generated electrical power against the connected load.



The logo of AIKTC (Atma Jyoti Knowledge & Technology Centre) is a circular emblem. It features a central illustration of a classical building with a dome and a palm tree in the foreground. The text 'AIKTC' is prominently displayed in the center of the emblem. Surrounding the central image are the names of the constituent institutions: 'ATMA JYOTI KALSEKAR ENGINEERING & TECHNOLOGY' on the left, 'TECHNICAL CAMPUS ARCHITECTURE & PHARMACY' on the right, and 'NEW PANVEL' at the bottom right. The location 'NAVI MUMBAI - INDIA' is written at the bottom of the emblem.

CHAPTER:- 04

DESIGN AND CALCULATION

4. DESIGN AND CALCULATION

4.1 STRUCTURAL DESIGN METHODS

This chapter describes some of the mathematical technique used by designers of complex structures. Mathematical models and analysis are briefly describe and detail description is given of the finite – element method of structural analysis. Solution techniques are presented for static, dynamic & modal analysis problems. As part of the design procedure the designer must be analyses the entire structure and some of its components. To perform this analysis the designer will develop mathematical models of structure that are approximation of the real structure, these models are used to determine the important parameters in the design. The type of structural model the designer uses depends on the information that is needed and the type of analysis the designer can perform. Three types of structural models are

- 1. Rigid Members:** The entire structure or parts of the structure are considered to be rigid, hence no deformation can occur in these members.
- 2. Flexible members:** The entire structure or parts of the structure are modeled by members that can deform, but in limited ways. Examples of this members trusses, beams and plates.
- 3. Continuum:** A continuum model of structure is the most general, since few if any mathematical assumptions about the behavior of the structure need to be made prior to making a continuum model. A continuum member is based on the full three – dimensional equations of continuum models.

In selecting a model of the structure, the designer also must consider type of analysis to be performed. Four typical analysis that designers perform are:

- 1. Static equilibrium:** In this analysis the designer is trying to determine the overall forces and moments that the design will undergo. The analysis is usually done with a rigid members of model of structure and is the simplest analysis to perform.
- 2. Deformation:** This analysis is concerned with how much the structure will move when operating under the design loads. This analysis is usually done with flexible members.
- 3. Stress:** In this analysis the designers wants a very detailed picture of where and at what level the stresses are in the design. This analysis usually done with continuum members.
- 4. Frequency:** This analysis is concerned with determining the natural frequencies and mode shape of a structure. This analysis can be done with either flexible members of a structure. This analysis can be done with either flexible members or continuum members but now the mass of the members is included in the analysis.

4.2. SOLAR SYSTEM

There are many factors that contribute to the development of an efficient and reliable solar powered system. Some of these factors include the determination of electric motor, solar panel voltage and current output and power transmission method.

4.2.1. Photovoltaic



<u>Panel Specifications</u>
12V, 240W
2 Panels of 100W
1 Panel of 40W
Panel Type = PV Solar Panel

Fig.4.1 Solar Panel

Photovoltaic modules convert sunlight directly into electricity in a process that is both elegant and simple. The cells in the modules are made from silicon, the most abundant element on earth after oxygen. Photovoltaic modules have no moving parts, which makes them inherently more reliable than other energy sources. They are appropriate for many applications, especially where conventional electric utility service is not available.

4.2.2 Solar Charge Controller



Fig.4.2 Charge Controller

A solar charge controller is fundamentally a voltage or current controller to charge the battery and keep electric cells from overcharging. It directs the voltage and current hailing from the solar panels setting off to the electric cell. The solar charge controllers control the reverse power flow. The charge controllers can distinguish when no power is originating from the solar panels and open the circuit separating the solar panels from the battery devices and halting the reverse current flow.[16]

4.2.3 Power Inverter



Fig.4.3 Power Inverter

A **power inverter** is an electronic device or circuitry that changes direct current (DC) to alternating current (AC).[17]

The input voltage, output voltage and frequency, and overall power handling depend on the design of the specific device or circuitry. The inverter does not produce any power; the power is provided by the DC source from photovoltaic.

A power inverter can be entirely electronic or may be a combination of mechanical effects (such as a rotary apparatus) and electronic circuitry. **Static inverters** do not use moving parts in the conversion process.

4.2.4. Battery



Fig.4.4 Battery

A battery is an electrochemical cell (or enclosed and protected material) that can be charged electrically to provide a static potential for power or released electrical charge when needed. It having specification of 12-volt 10-C 150-Ahr. Where 10C means battery will supply current for 10hrs after it has to be charge.

4.2.5 Calculation for Solar System

Table 4.1 Components & its specification for calculation

Sr. no	Components	No. of units	Voltage capacity	Working hours	Load (Wh)
1	Fan	1	80	8	640
2	Tube light	2	40	8	640
3	Mobile charger	1	4	2	12
4	Laptop	1	6	4	24
	Total				1320

Total Load = 1320Whr

FOS = 1.2 (Assume)

$$\text{Total Load} = 1320 \times 1.2$$

$$= 1600\text{Whr}$$

a) Inverter rating

$$\text{VA rating} = \frac{\text{Total Wattage}}{\text{Power Factor}}$$

$$= \frac{184}{0.7}$$

$$= 262.85 \text{ VA} \sim 263 \text{ VA}$$

Inverter Rating = 300VA

b) Battery Current

Battery of 12V

$$W = V \times I$$

$$1737.6 = 12 \times I$$

$$I = 144.8 \text{ Ahr} \sim 150 \text{ Ahr}$$

Where,

W= Load (Whr)

V= Voltage (V)

I = Current (Ahr)

c) Power Estimation

Voltage (V) = 12V

Current (I) = 150Ahr

$$\text{Power (P)} = V \times I$$

$$= 12 \times 150$$

$$= 1800 \text{ Wh}$$

Where, for 8 hours in day

$$P = \frac{1800}{8}$$

$$P = 225 \text{ W}$$

4.3 WIND TURBINE:

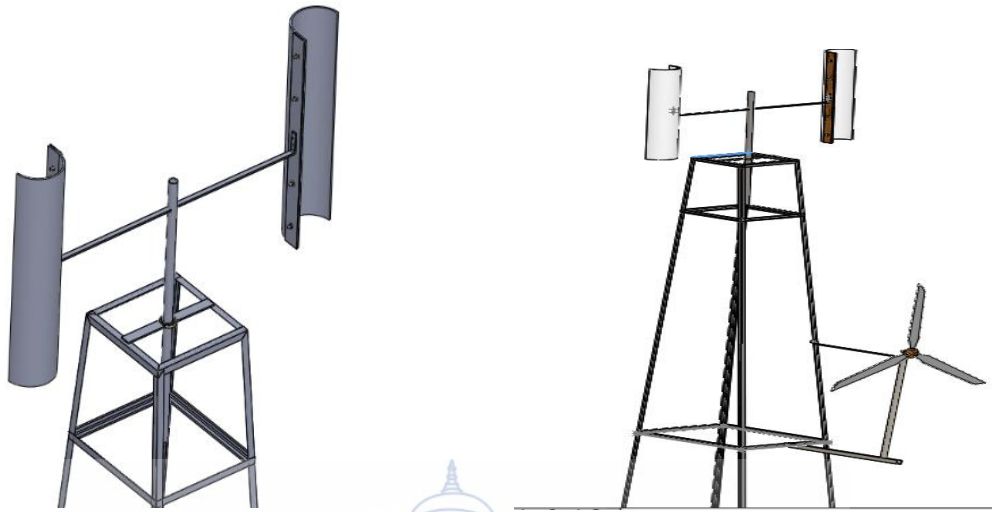

Fig.4.5 Software Model of Wind Turbine

4.3.1 Design for Wind Turbine

The fabrication of wind turbine for domestic purpose should meet the people economy and should be made with cost effective and reliable materials.

Materials

- PVC pipe
- M.S. shaft for tower
- Tin sheet for deflector

a) PVC pipe:

PVC has an amorphous structure with polar chlorine atoms in the molecular structure. Having chlorine atoms and the amorphous molecular structure are inseparably related. Although plastics seem very similar in the context of daily use, PVC has completely different features in terms of performance and functions compared with olefin plastics which have only carbon and hydrogen atoms in their molecular structures [18]



Fig.4.6 PVC Pipe

b) Tin Sheet deflector

Fig.4.7 Tin sheet deflector

Tin is a soft, pliable, silvery-white metal. Tin is not easily oxidized and resists corrosion because it is protected by an oxide film. Tin resists corrosion from distilled sea and soft tap water, and can be attacked by strong acids, alkalis and acid salts. The deflector is made up of from tin sheet.

4.3.2 Design of Blade

Fig.4.8 Horizontal Blades

Generally, wind turbine blades are shaped to generate the maximum power from the wind at the minimum construction cost. But wind turbine blade manufacturers are always looking to develop a more efficient blade design. Constant improvements in the design of wind blades has produced new wind turbine designs which are more compact, quieter and are capable of generating more power from less wind

In conclusion, a wind turbines rotor blade length determines how much wind power can be captured as they rotate around a central hub and the aerodynamic performance of wind turbine blades is very different between a flat blade and a curved blade. Flat blades are cheap and easy to make but have high drag forces making them slow and inefficient.

To increase the wind turbine blade efficiency, the rotor blades need to have an aerodynamic profile to create lift and rotate the turbine but curved aerofoil type blades are more difficult to make but offer better performance and higher rotational speeds making them ideal for electrical energy generation.[19]

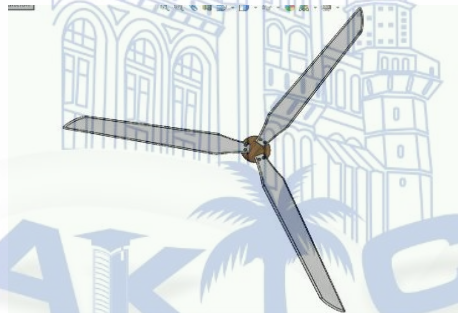
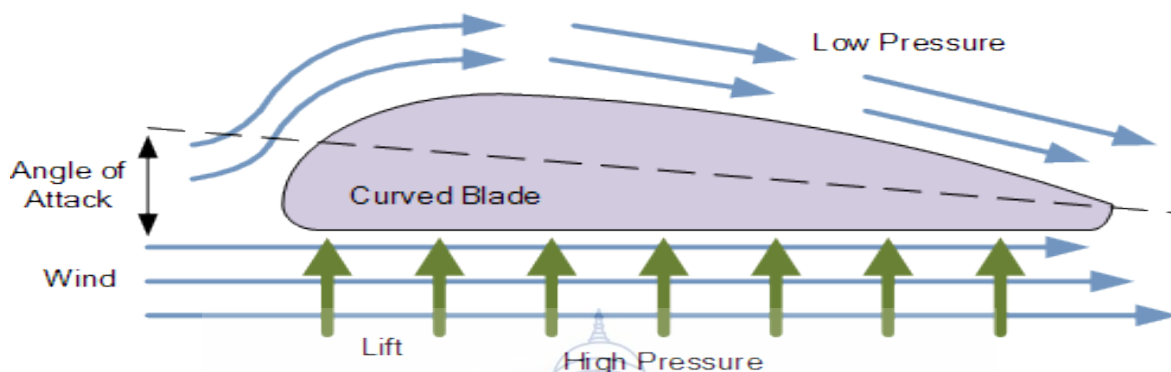

Fig .4.9 Curved Blade Air Flow and Performance ^[19]

4.3.2 Calculation for Wind System

– Wind Power depends on:

- Amount of air (volume)
- Speed of air (velocity)
- Mass of air (density) flowing through the area of interest (flux)

Kinetic Energy definition:

$$\text{K.E.} = \frac{1}{2} \times m \times v^2$$

Power is KE per unit time:

$$P = \frac{1}{2} \times m \times v^2$$

Mass flow rate = (Density \times Volume flux)

$$\frac{dm}{dt} = \rho \times A \times v$$

Thus

$$P = \frac{1}{2} \times \rho \times A \times v^3$$

Where,

Power \sim cube of velocity

Power \sim air density and Power \sim rotor swept area $A = \pi r^2$

$$\begin{aligned} P &= \frac{1}{2} \times \rho \times A \times v^3 \\ &= \frac{1}{2} \times 1.2 \times 1.3 \times 4^3 \\ &= 49.92 \text{ W} \end{aligned}$$

Where,

Swept Diameter = 1.28 m²

4.4 Hydro System



Fig.4.10 Pelton Wheel

4.4.1 Design For Hydro Turbine

In hydro power plant we use the gravitational force of water to run the pelton turbine which is coupled with electric generator to produce electricity. There are various types of turbines used for hydro power generation. Among them pelton turbine is use on medium to high head site.

a) Bucket and Runner:

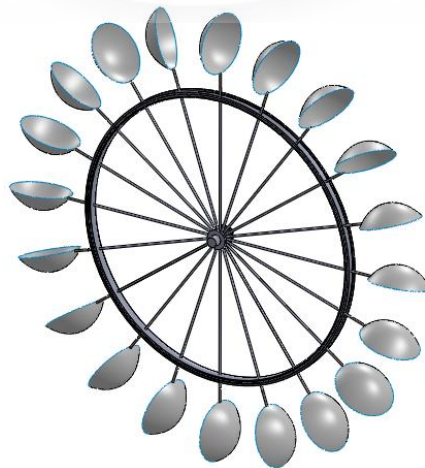

Fig.4.11 Buckets & Runner

Runner is a rotating part of the turbine consists of a circular disc fixed to a horizontal shaft. It is a circular disc on the periphery of which a number of buckets evenly spaced are fixed. Most vital component of Pelton wheel is its bucket. Buckets are casted as single solid piece, in order to avoid fatigue failure. The shape of the buckets is of a double hemispherical cup or bowl. Which is fabricated from spoons of stainless steel having 6.7 cm diameter and length of 7.0 cm. Each bucket is divided into two symmetrical parts by a dividing wall which is known as the splitter. The jet of water strikes on the splitter. Water jet is split into 2 equal components with help of a splitter. The special shape of bucket makes the jet turn almost 180 degree. This produces an impulsive force on bucket. Force so produced can easily be derived from Newton's 2nd law of motion. Blade outlet angle close to 180 degree is usually used in order to maximize impulsive force. A cut is provided at the tip of buckets. This makes sure that water jet will not get interfered by other incoming buckets.

b) Nozzle:

Generally, nozzle is used to control the flow rate of water. It converts the total head at the inlet of the nozzle into kinetic energy. Connected at the end of pipe to convert flow of water into jet pressure to strike on curve buckets. It is the circular guide mechanism, which guides the water to flow at designed direction and regulate the flow rate. A conical needle or spear operates inside the nozzle in an axial direction.



Fig.4.12 Nozzle

This spear controls the quantity of water flowing through the nozzle. The area of jet is reduced by pushing the spear forward inside the nozzle, this results in reduction of water quantity flowing through the jet. Similarly, if the spear is pushed back, the greater quantity of water is flow through the jet. Spear is controlled by automatic governing mechanism or by hand depending upon the need. Some additional nozzles, known as Bypass Nozzles are provided to avoid the bursting of pipe in case of sudden closing of water supply. Bypass nozzle don't allow water to strike the buckets. In some Pelton Wheel deflectors are provided in nozzle, which is used to defect the water jet and preventing it from striking the buckets.

c) Casing:

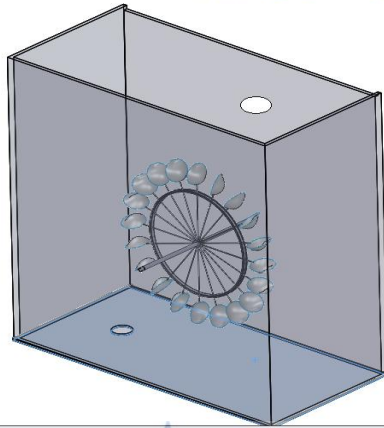

Fig.4.13 Casing For Hydro Turbine

The outer covering of the Pelton turbine is called casing. It also acts as a safeguard in the case of any accident occurs. It is, generally made up of cast or fabricated parts, to safeguard the runner and buckets assembly against accident and also. It prevents the splashing of the water and helps to discharge the water to the tail race. Casing of pelton turbine does not perform any hydraulic function.

4.4.2 Calculation of Hydro Power

Hydro power depends on:

Water flow rate (Q)

Velocity of jet (V)

Total Head (H)

Number of buckets (N)

The flow rate of water is calculated by calculating volume of tank and time require for filling the tank.

$$\text{Flow rate (Q)} = \frac{\text{volume}}{\text{Time (T)}}$$

$$\text{Volume of tank} = A \times L = 29.25 \times 0.1 = 2.925\text{m}^3$$

Time calculated for 30 minutes

So,

$$\begin{aligned} \text{Flow rate (Q)} &= \frac{2.925}{30 \times 60} \\ &= 1.625 \times 10^{-3} \text{ m}^3/\text{s} \end{aligned}$$

Numbers of buckets:

Total numbers of buckets depends on the jet ratio of water.

Diameter of turbine (D) = 0.4572m

Diameter of jet (d) = 0.0245

Jet ratio (m)

$$\begin{aligned} m &= \frac{D}{d} \\ &= \frac{0.4572}{0.0245} \\ &= 18 \end{aligned}$$

$$\begin{aligned} \text{Number of buckets} &= 15 + 0.5 \times m \\ &= 15 + 0.5 \times 18 \\ &= 24 \end{aligned}$$

Power Estimation

Height of building = 50ft = 15.24m

Length of pipe from bottom of tank = 1.85m

So,

$$\text{Total Head (H)} = 15.24 + 1.85 = 17.09\text{m}$$

There is some friction losses occurring in pipe. Therefore considering the friction head in total head.

Friction factor (f) = 0.01

Diameter of pipe = 2inch = 0.0508m

$$\text{Friction head, } hf = \frac{4fLQ^2}{12.1 \times d^5}$$

$$= \frac{4 \times 0.01 \times 17.09 \times (1.625 \times 10^{-3})^2}{12.1 \times (0.0508)^5}$$

$$hf = 0.44 \text{ m}$$

$$\begin{aligned} \text{Total Head} &= H + hf \\ &= 17.09 + 0.44 \\ &= 17.53\text{m} \end{aligned}$$

Gravity (g) = 9.81 m/s²

Power (P),

$$P = H \times Q \times g$$

$$= 17.53 \times 1.625 \times 10^{-3} \times 9.81$$

$$P = 279.4 \text{ W}$$

4.5 M.S angle tower:



Fig.4.14 M.S angle tower

Mild steel is a very popular metal and one of the cheapest types of steel available. It's found in almost every metal product. This type of steel contains less than 2 percent carbon, which makes it magnetize well. Since it's relatively inexpensive, mild steel is useful for most projects requiring huge amounts of steel. Mild steel does not have great structural strength, making it unsuitable for building girders or structural beams.

Most everyday products made from steel contain some mild steel material. Since it has a weak resistance to corrosion, mild steel must be painted or sealed to keep it from rusting. Putting a coat of grease or oil on mild steel also helps to protect it from corrosion.

Because it is a soft material, mild steel is easy to weld, whereas high-carbon steels, such as stainless steel, require the use of specialized welding techniques. Also, electricity can flow through mild steel easily without impacting its structural integrity. Mild steel is a variant of hard steels, which makes it much less brittle and enhances its flexibility.

4.6 Analysis of Pelton Bucket

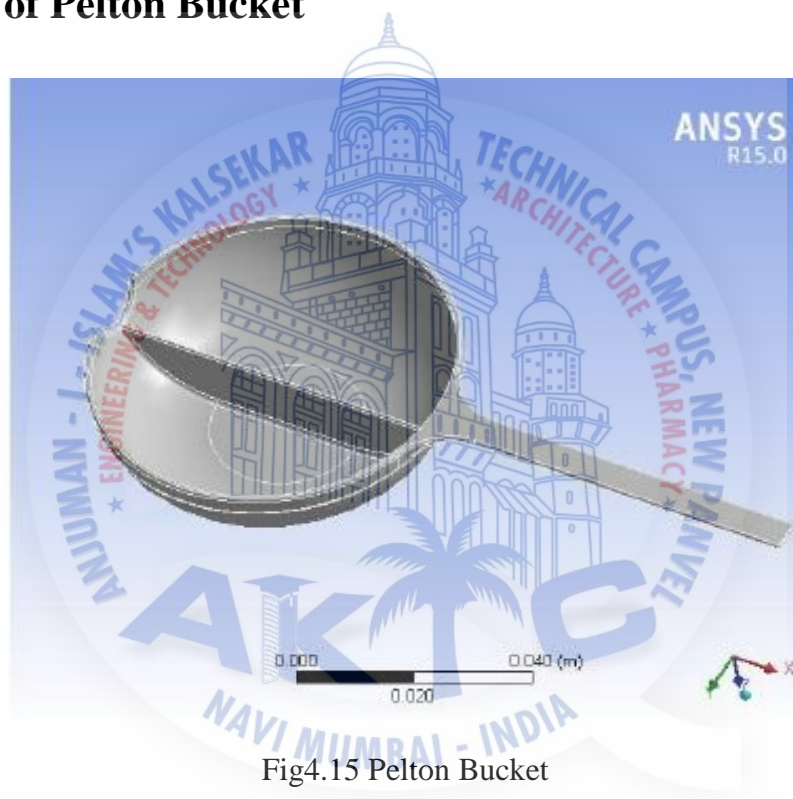

Fig4.15 Pelton Bucket

4.6.1 Material assigned and its Properties

The first step after importing the geometry in ANSYS for analysis is to assign the material to it for which the different properties of the material and certain constant has to be entered for customizing the material in material environment of the software. Following are the properties and constant which is entered during the time of analysis.

Table 4.2 Stainless Steel Properties

Compressive Yield Strength	2.07e+008 Pa
Tensile Yield Strength	2.07e+008 Pa
Density	7750 kg m ⁻³
Poisson ratio	0.31
Coefficient of Thermal Expansion	1.7e-005 C ⁻¹
Specific Heat	480 J kg ⁻¹ C ⁻¹
Thermal Conductivity	15.1 W m ⁻¹ C ⁻¹
Resistivity	7.7e-007 ohm m

4.6.2 Meshing Of Imported Geometry

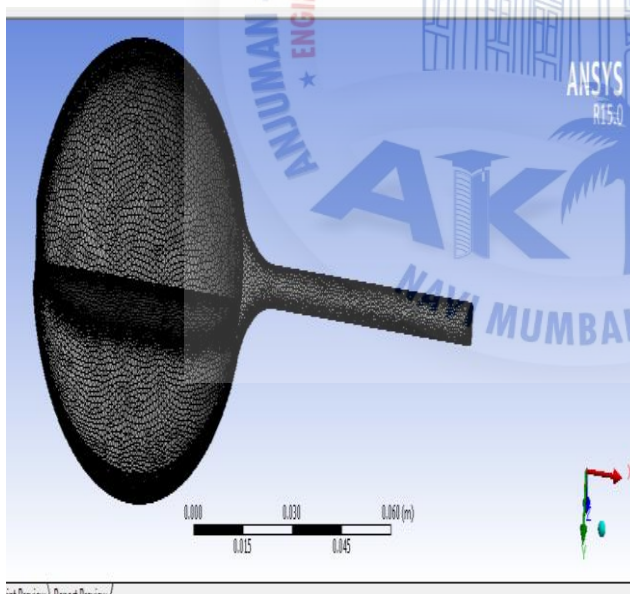

Fig.4.16 Mesh View

Minimum Edge Length	4.3793e-006 m
Inflation	
Patch Conforming Options	
Triangle Surface Mesher	Program Controlled
Patch Independent Options	
Topology Checking	Yes
Advanced	
Defeaturing	
Statistics	
<input type="checkbox"/> Nodes	436783
<input type="checkbox"/> Elements	271824
Mesh Metric	None

Fig.4.17 Mesh Detail

The meshing of the geometry is done on automatic mode and the number of nodes generated during meshing is 436783 and number of element generated during the meshing is about 271824 which is shown in mesh detail figure above.

4.6.3 Loads And Constraints

Once the meshing is done and nodes and elements are formed the next step is to apply load and give constraint to the geometry. In this geometry the water pressure is applied at the centre of bucket and the constraint is given at bottom most portion where it is welded to the rim of the pelton wheel as shown in figure below.

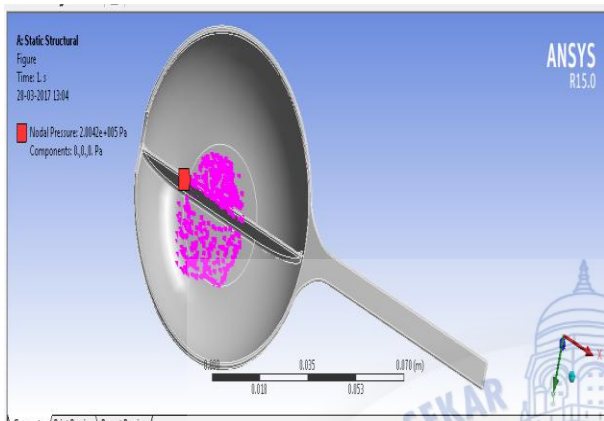

Fig.4.18 Pressure Applied

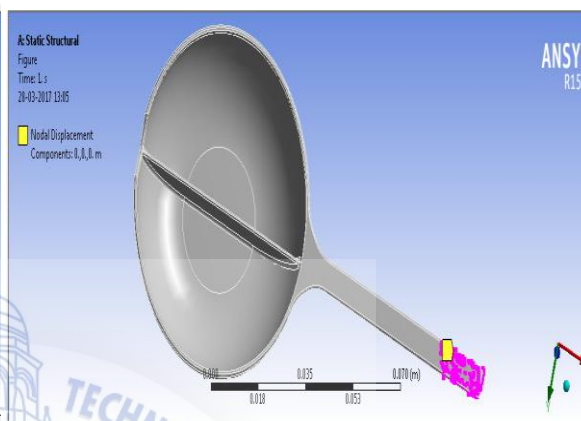

Fig.4.19 Constraint and Fixed

The displacement at the fixed node is 0 m in all coordinate system such as X,Y,Z components

4.6.4 Results

Once all the above process is completed by the solver of the software named as Mechanical APDL the solver will solve the given condition and it will show the deformation, stress induced and the strain when it is subjected to the amount of pressure applied. This will clearly show the behaviour of the geometry under such condition and how safe is the component. Following figures shows the deformation, stresses induced and strain in the components and it is tabulated in table no [4.3], [4.4]

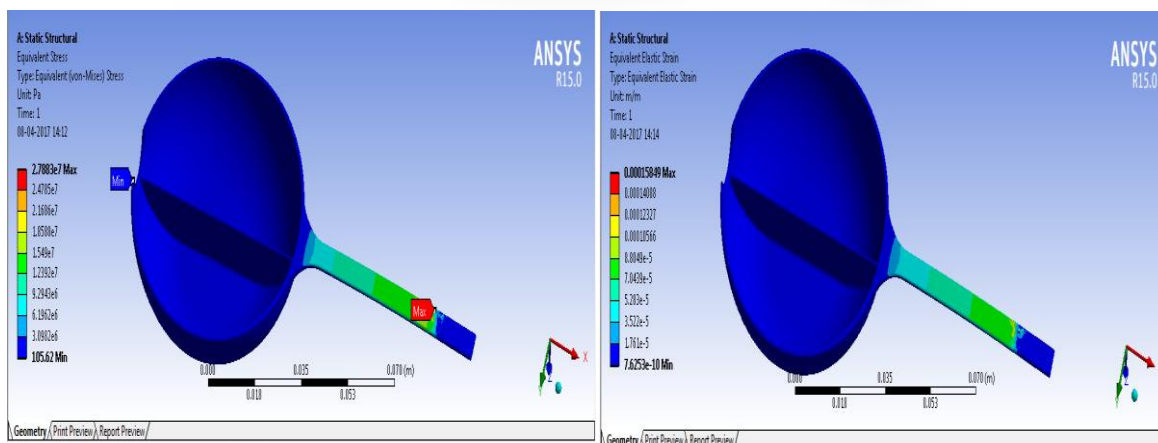

Fig.4.20 Equivalent Stress & Strain

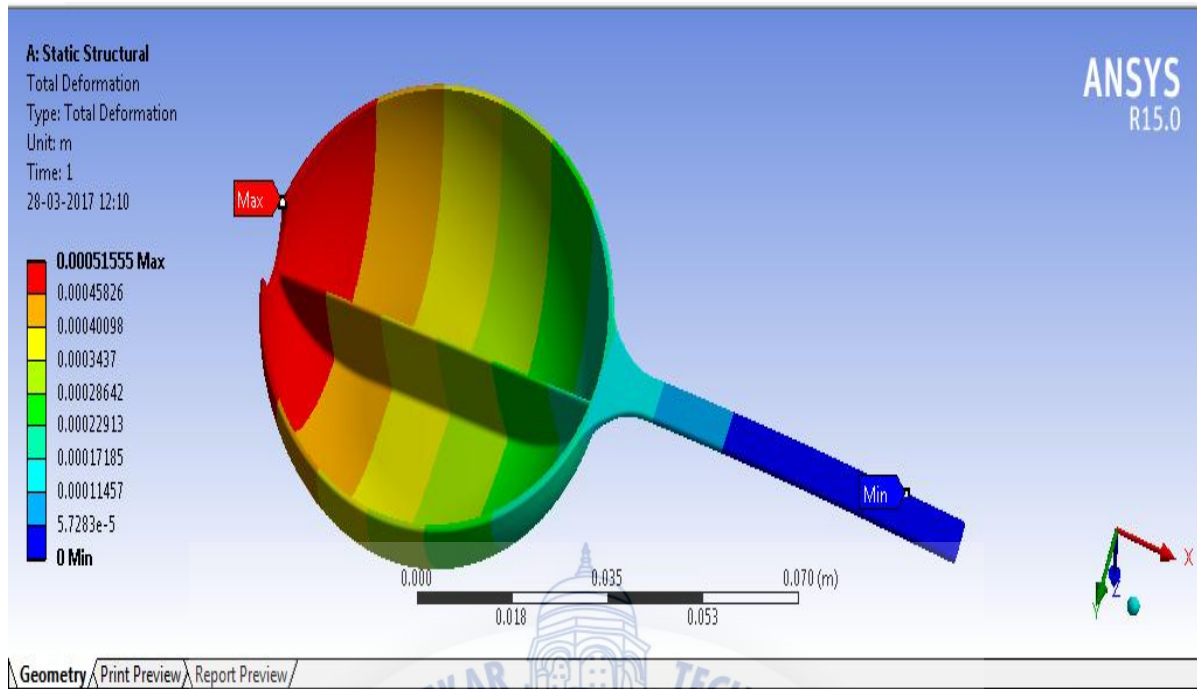

Fig.4.21 Deformation

Table 4.3 Deformation at different Pressure

Pressure (bar)	Maximum deformation (m)	Minimum deformation (m)
6	0.000515	0
8	0.000912	0
10	0.0020509	0

Table 4.4 Stress at different Pressure

Pressure (bar)	Maximum stress (Pa)	Minimum stress (Pa)	FOS
6	2.7833×10^7	105.62	7.43
8	6.9146×10^7	204.58	3.01
10	1.3573×10^8	514.12	1.52

In this analysis we are more interested in deformation of bucket along with the stress induced in it. It is seen from the deformation table that the domestic pelton bucket can sustain a pressure up to 10 bar with the deformation of 2.0mm with further increase in pressure it will break as the thickness of it is 2.0mm.



CHAPTER NO.:- 05
FABRICATION

5. FABRICATION

5.1 MATERIAL SELECTION

The proper selection of material for the different part of a machine is the main objective in the fabrication of machine. For a design engineer it is must that he be familiar with the effect, which the manufacturing process and heat treatment have on the properties of materials. The Choice of material for engineering purposes depends upon the following factors:

1. Availability of the materials.
2. Suitability of materials for the working condition in service.
3. The cost of materials.
4. Physical and chemical properties of material.
5. Mechanical properties of material.

The mechanical properties of the metals are those, which are associated with the ability of the material to resist mechanical forces and load. We shall now discuss these properties as follows:

1. **Strength:** It is the ability of a material to resist the externally applied forces.
2. **Stress:** Without breaking or yielding. The internal resistance offered by a part to an externally applied force is called stress.
3. **Stiffness:** It is the ability of material to resist deformation under stresses. The modulus of elasticity is the measure of stiffness.
4. **Elasticity:** It is the property of a material to regain its original shape after deformation when the external forces are removed. This property is desirable for material used in tools and machines. It may be noted that steel is more elastic than rubber.
5. **Plasticity:** It is the property of a material, which retain the deformation produced under load permanently. This property of material is necessary for forging, in stamping images on coins and in ornamental work.
6. **Ductility:** It is the property of a material enabling it to be drawn into wire with the application of a tensile force. A ductile material must be both strong and plastic. The ductility is usually measured by the terms, percentage elongation and percent reduction in area. The ductile materials commonly used in engineering practice are mild steel, copper, aluminum, nickel, zinc, tin and lead.

7. **Brittleness:** It is the property of material opposite to ductile. It is the Property of breaking of a material with little permanent distortion. Brittle materials when subjected to tensile loads snap off without giving any sensible elongation. Cast iron is a brittle material.
8. **Malleability:** It is a special case of ductility, which permits material to be rolled or hammered into thin sheets, a malleable material should be plastic but it is not essential to be so strong. The malleable materials commonly used in engineering practice are lead, soft steel, wrought iron, copper and aluminum.
9. **Toughness:** It is the property of a material to resist the fracture due to high impact loads like hammer blows. The toughness of the material decreases when it is heated. It is measured by the amount of absorbed after being stressed up to the point of fracture. This property is desirable in parts subjected to shock an impact loads.
10. **Resilience:** It is the property of a material to absorb energy and to resist rock and impact loads. It is measured by amount of energy absorbed per unit volume within elastic limit. This property is essential for spring material.
11. **Creep:** When a part is subjected to a constant stress at high temperature for long period of time, it will undergo a slow and permanent deformation called creep. This property is considered in designing internal combustion engines, boilers and turbines.
12. **Hardness:** It is a very important property of the metals and has a wide variety of meanings. It embraces many different properties such as resistance to wear scratching, deformation and mach inability etc. It also means the ability of the metal to cut another metal. The hardness is usually expressed in numbers, which are dependent on the method of making the test. The hardness of a metal may be determined by the following test.
- Brinell hardness test
 - Rockwell hardness test
 - Vickers hardness (also called diamond pyramid) test and
 - Share scaleroscope.

The science of the metal is a specialized and although it overflows in to realms of knowledge it tends to shut away from the general reader. The knowledge of materials and their properties is of great significance for a design engineer. The machine elements should be made of such a material which has properties suitable for the conditions of operations. In addition to this a design engineer must be familiar with the manufacturing processes and the heat treatments have on the properties of the materials. In designing the various part of the machine it is necessary to know how the material will function in service. For this certain characteristics or mechanical properties mostly used in mechanical engineering practice are commonly determined from

standard tensile tests. In engineering practice, the machine parts are subjected to various forces, which may be due to either one or more of the following.

1. Energy transmitted
2. Weight of machine
3. Frictional resistance
4. Inertia of reciprocating parts
5. Change of temperature
6. Lack of balance of moving parts

The selection of the materials depends upon the various types of stresses that are set up during operation. The material selected should with stand it. Another criteria for selection of metal depend upon the type of load because a machine part resist load more easily than a live load and live load more easily than a shock load.

Selection of the material depends upon factor of safety, which in turn depends upon the following factors.

1. Reliabilities of properties
2. Reliability of applied load
3. The certainty as to exact mode of failure
4. The extent of simplifying assumptions
5. The extent of localized
6. The extent of initial stresses set up during manufacturing
7. The extent loss of life if failure occurs
8. The extent of loss of property if failure occurs

5.2 MACHINING OF PARTS

5.2.1 General Workshop Technology

The components of project models have been machined to the required dimensions on the center lathe machine.

The raw material stocks are either cut to size on power hacksaw machine or by hand hack saw on the worktable.

The drilling of notes have been carried out on drill machine prior to scribing the center lines & cross lines & marking out the inch marks at the drill centers.

1) Hack Saw Cutting:-

The speed is 350RPM & the feed is automatic, maintain a cutting margin of about 3 to 5 mm. Extra for large sections & 1 to 2 mm extra for light sections. This is an Auto operation.



Fig.5.1 Hacksaw machine

2) Lathe Machine:-

a) Facing & turning speed - 650 to 850 rpm.

b) Polishing Speed – 1000 rpm.



Fig.5.2 Lathe machine

Cutting Tools:-

- i) Tungsten carbide Tipped tools either side or crank types.
- ii) Parting tools or V threading tools.
- iii) High speed steel tools (H.S.S.)

3) Drill Machine :-

- i) Parallel shank in H.S.S. – Reading
- ii) Taper shank in H.S.S. – available



Fig.5.3 Drill Machine

4) Coolants & Cutting Oils :-

- i) Proprietary Brand: - For machining M.S., L.C.S.

Hindustan petroleum Oil H.S.C. Alloy Steels & Stainless Steels.

Mixed in water in 1:10 ratio

- ii) Kerosene:-For machining of all grades of L.M. – 1 to L.M. - 6 Aluminium.....(L.M. = Light Metal)

- iii) No cutting Oil or coolant: - For machining in dry state of brass copper, Cast iron, raw material.

5) **Threading** :- Light duty threading is done with the help of H.S.S. Tap set (Inside Threading) & H.S.S. Round Dies (outside threading) by hand tap & die wrenches.

6) **Drilling of Holes** :- Please note that similar the hole 'x' dia. The higher the speed. Larger the hole dia., lower the speed. Micro drilling speeds are above 1000 rpm.

7) **Reaming of Holes** :- Drilled or bored holes are finished to close tolerance by parallel or taper shank reamers readily available in the market.

8) **Grinding** :- Grinding of frame material, pelton buckets and blades is carried out with the help of the hand grinder and by using the bench grinder machine having fine and coarse wheels.



Fig.5.4 Grinding Machine



Fig.5.5 Bench Grinding Machine

9) **Polishing** :- Polishing is the inside & outside surface of the machined parts is required to with stand ere & teat & also for smooth vibration free operation, polishing parts are available in the market & generally designed as valve grinding & polishing compounds.

10) **Measuring Instruments:-** During Machining operations the dimensions are measured accurately by using:- Hand Verniers, Micrometers, Merrier Depth Gauges, Thread Gauges. Radius Gauges, Go/No-Go Plug Gauges, Snap Gauges, Inside & Outside Calipers.



Fig.5.6 Measuring Tape



Fig.5.7 Vernier Caliper



Fig.5.8 Measuring scale

11) **Fabrication:** - Various steel sections are aluminium sections are employed in the fabrication work such as angles, clits, gussets, fillets flats & the round bars. These sections are cut to required size marked for drilled holes & then fastened together with the help of rivets & bolts, Nuts & Screws. Welding, Brazing & Soft Soldering of fabricated joints are obtained from outside parties & not in the consoler's workshop.

- i) Electric Arc Welding : For heavy duty parts.
- ii) Gas Welding : For light duty parts.

- iii) Gas Brazing : For Brass & copper parts.
 iv) Soft Tin soldering : For light duty parts in M.S. Brass & copper.

5.2.2 COMPONENT: - FRAME

MATERIAL: - M.S. ANGLE

Table 5.1 Process for manufacturing of Frame

SR.NO	DESCRIPTION OF OPERATION	MACHINE USED	MEASUREMENT	TIME
1	Cutting the angle in to length as per drawing	Gas cutting machine	Measuring tape	10 min.
2	Marking and Cutting the angle in to number of piece as per drawing.	Power hacksaw and electric hand cutter	Steel rule and Measuring tape	30 min.
3	Filing operation can be performed on cutting side and bring it in perpendicular C.S.	Bench vice	Try square	15 min.
4	Fitting the piece of angle which is cut and filed in proper dimensions.		Try square	40 min.
5	Weld the angles as per the fitting is done.	Electric arc welding machine	Try square	25 min



Fig.5.9 L angle



Fig.5.10 Marking and cutting of angle



Fig.5.11 Welding of chassis



Fig.5.12 Chassis

5.2.3 Component: -Blade

MATERIAL: - PVC

QUANTITY: - 5

Table 5.2 Process of manufacturing of blade

SR.NO	DESCRIPTION OF OPERATION	MACHINE USED	MEASUREMENT	TIME
1	Marking of the blade profile on the PVC material as per the design and dimensions.		Scale	25 min.
2	Cutting of the marked blade profile on PVC	Electric hand cutter	Scale	30 min.
3	Grinding the edge portion of blades following the profile marked.	Grinding machine and Electric hand grinder		20 min.
4	Drill the hole on the blades as per the required diameter after marking on correct position.	Pillar Drill Machine	Vernier calliper	20 min.



Fig.5.13 Blades Manufacturing

5.2.4 Component: - Shaft

MATERIAL: - MS

Table 5.3 Process of manufacturing of Shaft

SR.NO	DESCRIPTION OF OPERATION	MACHINE USED	TOOL USED	MEASURING INSTRUMENT	TIME
1.	Marking on shaft	-	-	Scale	5 min
2.	Cutting as per drawing	Power hack saw	Hack saw blade	Scale	5 min
3.	Facing both side of shaft	Lathe machine	Single point cutting tool	Vernier caliper	25 min
4.	Turning as per required size	Lathe machine	Single point cutting tool	Vernier caliper	60 min
5.	Key way on end of shaft	Milling machine	Milling cutter	Vernier caliper	10 min



Fig.5.14 Turning process



Fig.5.15 Shaft and Flange

5.2.5 Component: -Bucket

MATERIAL: - STEEL

QUANTITY: - 18

Table 5.4 Process of manufacturing of Pelton Buckets

SR.NO	DESCRIPTION OF OPERATION	MACHINE USED	MEASUREMENT	TIME
1	Cut the spoons as per the designed length.	Electric hand cutter	Scale	30 min.
2	Mark and Cut the splitter for bucket	Electric hand cutter	Scale	60 min.
3	Marking notch profile at the upper edge of the spoon	Electric hand grinder	Scale	30 min.
4	Grinding of notch shape profile on bucket	Bench grinder	-	50 min.
5	Welding of bucket on the wheel	TIG welding machine	-	180 min

5.3 ACTUAL SETUP



Fig.5.16 Actual Pelton Wheel turbine



Fig.5.17 Actual Pelton Bucket



Fig.5.18 Actual set of Hydro Turbine



Fig.5.19 Actual setup of Wind Turbines



Fig.5.20 Actual setup of solar system



Fig.5.21 Actual setup of Combined System

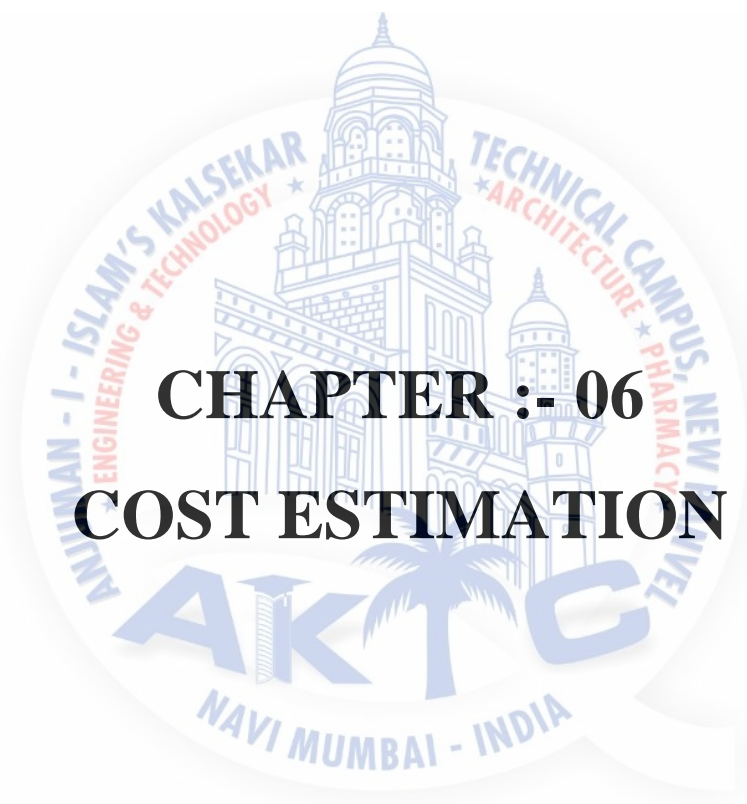

CHAPTER :- 06

COST ESTIMATION

6. COST ESTIMATION

Cost estimation may be defined as the process of forecasting the expenses that must be making, tool, making as well as a portion of the general administrative and selling costs.

6.1 Purpose of cost estimation

1. To determine the selling price of a product for a quotation or contract so as to ensure a reasonable profit to the company.
2. Check the quotation supplied by vendors.
3. Determine the most economical process or material to manufacture the product.
4. To determine standards of production performance that may be used to control the cost.

Incurred to manufacture a product. These expenses take into a consideration all expenditure involved in a design and manufacturing with all related services facilities such as pattern

6.2 Basically the budget estimation is of two types:

1. Material cost
2. Machining cost

6.2.1 Material Cost Estimation

Material cost estimation gives the total amount required to collect the raw material which has to be processed or fabricated to desired size and functioning of the components.

These materials are divided into two categories.

1. Material for fabrication : In this the material in obtained in raw condition and is manufactured or processed to finished size for proper functioning of the component.
2. Standard purchased parts : This includes the parts which was readily available in the market like allen screws etc. A list is forecast by the estimation stating the quality, size and standard parts, the weigh of raw material and cost per kg. For the fabricated parts.

6.2.2 Machining Cost Estimation

This cost estimation is an attempt to forecast the total expenses that may include to manufacture apart from material cost. Cost estimation of manufactured parts can be considered as judgment on and after careful consideration which includes labour, material and factory services required to produce the required part.

6.3 Procedure for calculation of material cost

The general procedure for calculation of material cost estimation is

1. After designing a project a bill of material is prepared which is divided into two categories.
 - a. Fabricated components
 - b. Standard purchased components
2. The rates of all standard items are taken and added up.
3. Cost of raw material purchased taken and added up.

6.4 Labour cost:

It is the cost of remuneration (wages, salaries, commission, bonus etc.) of the employees of a concern or enterprise.

Labour cost is classified as:

- 1 Direct labour cost
- 2 Indirect labour cost

6.4.1 Direct Labour Cost

The direct labour cost is the cost of labour that can be identified directly with the manufacture of the product and allocated to cost centers or cost units. The direct labour is one who counters the direct material into saleable product; the wages etc. of such employees constitute direct labour cost. Direct labour cost may be apportioned to the unit cost of job or either on the basis of time spend by a worker on the job or as a price for some physical measurement of product.

6.4.2. Indirect Labour Cost

It is that labour cost which cannot be allocated but which can be apportioned to or absorbed by cost centers or cost units. This is the cost of labour that doesn't alter the construction, confirmation, composition or condition of direct material but is necessary for the progressive movement and handling of product to the point of dispatch e.g. maintenance, men, helpers, machine setters, supervisors and foremen etc.

The total labour cost is calculated on the basis of wages paid to the labour for 8 hours per day.

Cost estimation is done as under

Cost of project = (A) material cost + (B) labour cost + (C) indirect cost

(A) Material cost is calculated as under :-

- i) Raw material cost
- ii) Finished product cost

Material cost (A):-

It includes the material in the form of the Material supplied by the "Steel authority of India limited" and 'Indian aluminum co.,' as the round bars, angles, square rods, plates along with the strip material form. We have to search for the suitable available material as per the requirement of designed safe value.

Hence the cost of material is as follows:

Table 6.1 Material Cost

SR.NO.	COMPONENT	SPECIFICATION	NOS	COST
1	BATTERY	12V,10-C	1	8600
2	PRIORITIZER	30Amp	1	3200
3	SOLAR PANEL	100W 12V	1	8000

4	INVERTER	400KVA	1	2500
5	PVC PIPE	150mm DIAMETER	1	100
6	RAW MATERIAL	'L' SHAPE		500
7	HYDRO CASING	PLASTIC MT.	1	1080
8	WIRES	16 mm ²	-	5000
9	BEARING		6	950
10	NUT BOLTS			1000
11	MISCELLANEOUS			2000
			TOTAL	32930/-

Direct cost (b):-

Table 6.2 Direct Cost

SR. NO.	OPERATION	HOURS	AMOUNT
1.	Turning	12	-
2.	Drilling	5	-
3.	Welding	24	500
4.	Grinding	8	500
5.	Tapping	3	-
6.	Cutting	10	500
			1500/-

Indirect cost (c):-

Transportation cost = Rs.1000

Project report cost = Rs.2000

C = Rs.3000

Total cost

STD Parts Cost + Direct Labour Cost +Indirect Cost

$$= A + B + C$$

$$= 32930 + 1500 + 3000$$

$$= 37,430/-$$



The logo of AIKTC (A. K. Jaiswal Institute of Technology & Computer) is a circular emblem. It features a central illustration of a classical building with a dome and a palm tree in the foreground. The text 'AIKTC' is prominently displayed in the center of the emblem. Surrounding the central image are the names of the parent institutions: 'AL-ANJUMAN - ISLAM'S KALSEKAR' on the left and 'TECHNICAL CAMPUS NEW PANVEL' on the right. Below the main emblem, a banner reads 'NAVI MUMBAI - INDIA'.

CHAPTER: -7

RESULT AND DISCUSSION

7. RESULT AND DISCUSSION

Energy generation from:

- SOLAR: 1280Wh (If working for 8 hours in a day with 80% efficiency).& cost saving is around 260 Rs per month.
- WIND: 110Wh (If working for 8hr in a day with 60% efficiency) & cost saving is around 75 Rs per month.
- HYDRO: 220Wh (If working for 8hr in a day with 60% efficiency) & cost saving is around 150 Rs per month.
- Total power generation: 1800 wh
- Required power generation: 1600 wh

Total power generation > Required power generation

- By this project we can save **485 Rs per month** & the cost required for this project can be payback in **7.52 years** & after that it will be free with negligible maintenance cost.
- So by this project we are not only producing electric energy but also contributing towards eco-friendly environment.

CHAPTER:-08
PAPER PUBLISHED

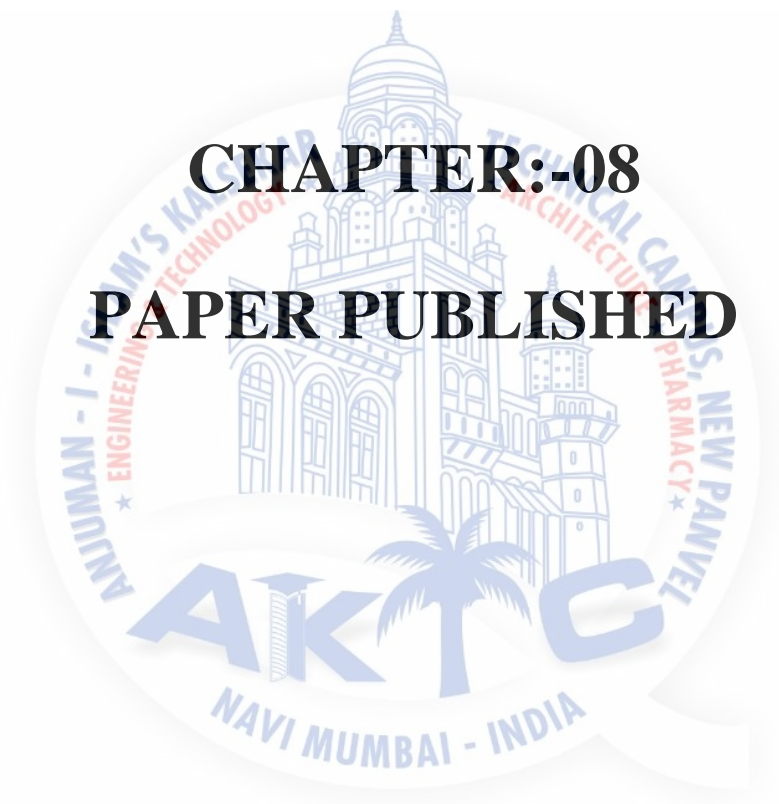

8. PAPER PUBLISHED

A) DESIGN AND FABRICATION OF DOMESTIC WIND TURBINE

The continuous increase in demand of electricity makes it necessary for everyone to have its availability and also during power cut-off. For this, people are moving towards the renewable energy sources. Wind is one of the most important renewable energy which drags and sparks the houses because of non-conventional energy sources. Since wind product power in a cubic relation with the wind speed, people conscience towards the wind sources has increased and also it is free of cost and doesn't emit any greenhouse gases. In this study, they elucidate the wind energy for power generation at domestic level of use at optimum rate so that people will be benefited through its use.[20]

B) DESIGN AND FABRICATION OF DOMESTIC HYDRO TURBINE

Day by day the demand of electricity increases, due to growing population & commercialization. The power consumption is more than generation by conventional method. Hence, hydroelectricity exist as one of the option to meet the growing demand for energy by nonconventional method. The performance of hydro turbine is strongly influence by the characteristic of water inertia.[21]

CHAPTER:-09

CONCLUSION

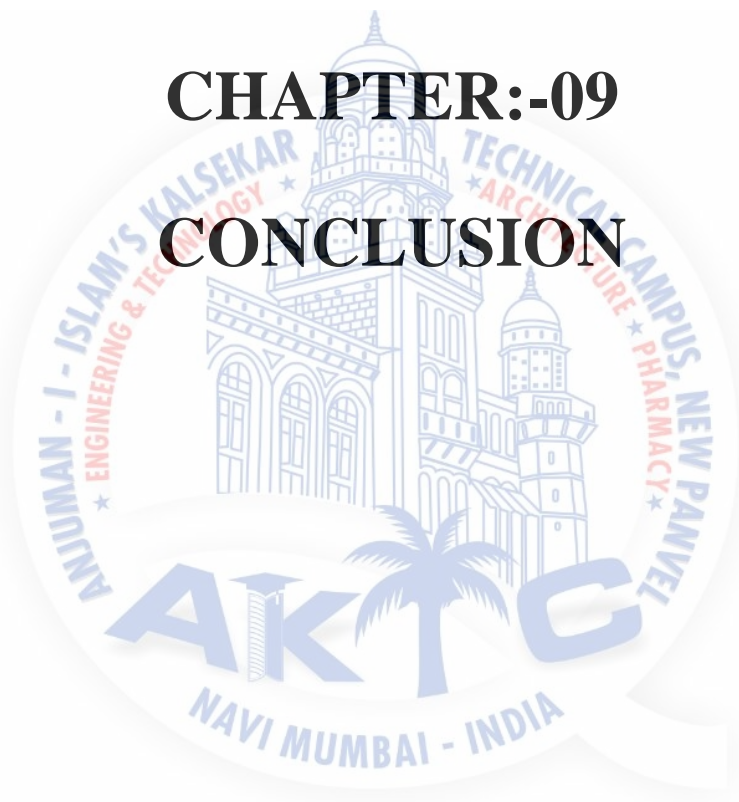

9. CONCLUSION

The nonconventional energy sources are those that everyone can rely. Due to the depleting fossil fuels, people's consciousness towards the renewable energy increases. Perhaps the combination of wind solar and hydro is the feasible option for commercial and domestic purpose. If we combine these three domains we can get the advantage of these three.

The load demand is 200W for a cabin for 8hrs .the combination of wind, solar and hydro gives individual contribution to run the cabin for 8hrs or whole day. we will get the load demand of 200W.when we add up the load demand with some more value viz wiring loss, mechanical loss etc.

By this project, we got 50W from wind, 100W from hydro and 100W from solar. This contribution is feasible for domestic and commercial application especially where there is a load shading problem Also the main advantage of hydro domain is that the Water which is used for domestic appliances, same water can be utilized for production of energy.

Since the material used and setup installation constitute less cost compare to conventional one, so by this everyone can be benefited from this type of project at optimum rate.

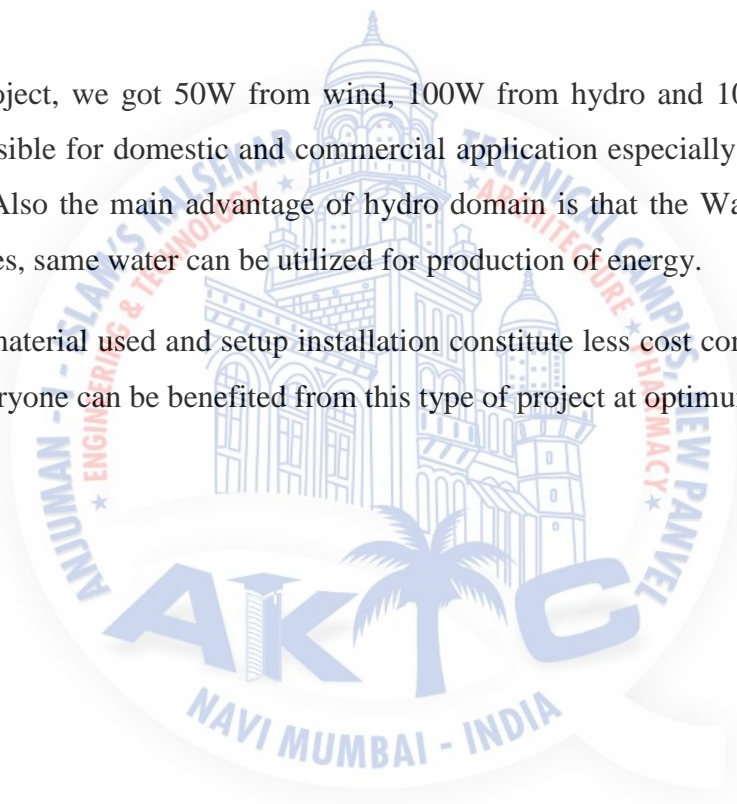

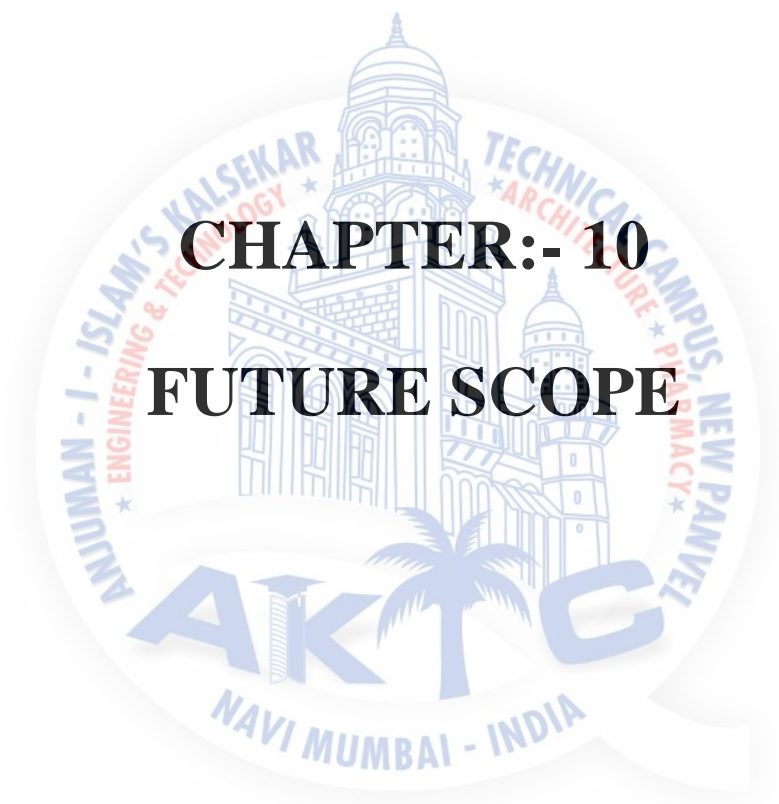

CHAPTER:- 10

FUTURE SCOPE

10. FUTURE SCOPE

The sources such as solar, wind, and hydro energy used to generate the electricity in this project will never going to end and stop. Further improvement in the wind mill can be done by using the standard type of it when it is installed for large amount of power generation. Grid Tie solar panels can be used when the load capacity is very large.

In this project attempt is made to run one cabin of the department. The system can be expanded in future to supply the power for the whole department admin. Many labs in college consist of large quantity of fan, light along with this there is also high power consuming machines which are used for performing practical. The system can be used for the supply of electricity to fans and tube lights of that lab so that the energy required for running the same is eliminated and there will be a reduction in the MSEB electricity bill. Labs in which the practical are performed completely on computers can be equipped with these Non-conventional sources so that whenever there is cut off in supply the practical will not get disturb just because of the disconnect of the power supply.

The electricity bill of the college is very high so by adopting the power supply from the non-conventional source large amount of energy can be saves which will result in saving the liquidity and hence reduction in electricity bill of the college.

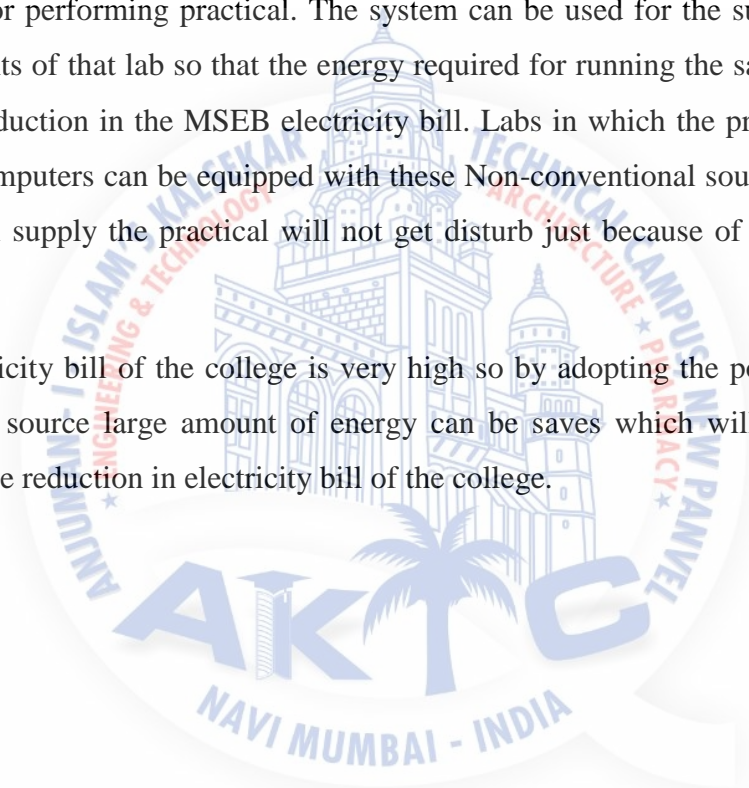

APPENDIX I

A) Calculation for Solar Power

Appliances	No of Appliances	Wattage Capacity (W)	Working Hours in Day	Requirement in Whr
Fan	1	80	8	640
Light	2	40	8	640
Mobile Charger	1	4	2	8
Laptop Charger	1	6	2	12
		TOTAL CONNECTED LOAD (Whr)		
Total Requirement	=	1320		
Factor of Safety	=	1.2		
Actual Requirement	=	1600		
		BATTERY CAPACITY (Amp-hr)		
Battery Voltage	=	12V		
Battery Amp-hr	=	144.8		
		SOLAR PANEL SPECIFICATION		
Voltage	=	12V		
Wattage Required	=	267.6		

B) Calculation for Wind Power

<u>Parameter</u>	<u>Value</u>
Air Density(kg/m ³)	1.2
Velocity Of Air(m/s)	4
Diameter Of Blade(m)	1.28
Area of Blade(m ²)	2.215584
Betz Limit	0.592592593
Turbine Power	49.92

C) Calculation for Hydro Power

Diameter of Jet (m)	0.0254
Diameter of turbine (m)	0.4572
Flow Rate(m ³ /s)	0.001625
Area of pipe(m ²)	0.002025802
Velocity of flow(m/s)	0.802151286
Speed of Turbine(rpm)	150
Area of jet(m ²)	0.000506451

Velocity of Jet(m/s)	17.89781596
Blade Velocity(m/s)	3.58902
Relative Velocity at Inlet(m/s)	14.30879596
Relative Velocity at Outlet(m/s)	12.87791636
Whirl Velocity at inlet(m/s)	17.89781596
Whirl Velocity at Outlet(m/s)	-8.850534258
Water power(kW)	0.279450113
Theoretical discharge (m³/s)	0.00906436
Jet Ratio	18
No of buckets(Z)	24

APPENDIX II

PROPOSAL TO ANJUMAN I-ISLAM KALSEAKR TECHNICAL CAMPUS, NEW PANVEL, FOR GRID TIE SOLAR POWER GENERATION SYSTEMS

CALCULATIONS:

MSEB electrical consumption units :

Jan – 2017	41733 units
Dec – 2016	36957 units
Nov – 2016	39926 units
Oct – 2016	54990 units
Sept - 2016	47381 units
Aug – 2016	48707 units.
TOTAL	2,69,694 units

For one month 44,949 units i.e. approx 45,000 units per month.

For one day unit consumed is 1500 units per day

So, grid tie solar power generation systems will be of capacity in KWp as follows.

Since one Kw Solar Power Generation Systems generates 4 units per day with 6hrs of solar radiation.

$$\text{Capacity of panel} = \frac{\text{no of unit per month}}{\text{Unit per KWp}}$$

$$\text{Capacity of panel} = \frac{1500}{4}$$

$$= 375.0 \text{ KWp}$$

We proposed to college Solar Power Generation Grid- Tie Systems of 375 KWp so there will be minimum MSEB Electricity Bills. The Electricity Bill of per Months for **45000 Unit** is **Rs. 5,60,000/-** per month. & cost of the proposed project is **Rs. 3,18,75,000/-** with 25-30 years of Systems Life. The pay back or Break even will in **5.5 years**. It is found that the proposed solar power generations system is viable. **Subsidy which the college will get can be utilised for maintenance purpose which include minor maintenance like cleaning of solar panels etc.**

REFERENCES

- [1] Nada Kh. M. A. Alrikabi " *Renewable Energy Types* " Journal of Clean Energy Technologies, Vol. 2, No. 1, January 2014
- [2] Web Link : <http://www.eschooltoday.com/energy/renewable-energy/what-is-renewable-energy.html>
- [3] Web Link : <https://indiastatistical.wordpress.com/2006/10/03/indian-energy-scenario/>
- [4] K.S. Sidhu, Director/Research, Punjab State Electricity Board, PEC Campus, Chandigarh " *NON-CONVENTIONAL ENERGY RESOURCES* "
- [5] Web Link : <http://governancetoday.co.in/non-conventional-sources-power-future/>
- [6] Web Link : <http://www.conserve-energy-future.com/causes-and-solutions-to-the-global-energy-crisis.php>
- [7] K.S. Sidhu, Director/Research, Punjab State Electricity Board, PEC Campus, Chandigarh " *Non-Conventional Energy Resources* "
- [8] Mostefa Ghassoul " *Design of an Automatic Solar Tracking System to Maximize Energy Extraction* " International Journal of Emerging Technology and Advanced Engineering, Volume 3, Issue 5, May 2013
- [9] T.M. Razykov, C.S. Ferekides, D. Morel, E. Stefanakos, H.S. Ullal, H.M. Upadhyaya, " *Solar photovoltaic electricity: Current status and future prospects* " Science Direct, Solar Energy 85 (2011) 1580–1608
- [10] Medugu, D. W. & Michael, E., " *Integrated Solar – Wind Hybrid Power Generating System for Residential Application* " Global Journal of Researches in Engineering:Electrical and Electronics Engineering, Volume 14 Issue 4 Version 1.0 Year 2014
- [11] Ashish S. Ingole, Prof. Bhushan S. Rakhonde " *Hybrid Power Generation System Using Wind Energy and Solar Energy* ", International Journal of Scientific and Research Publications, Volume 5, Issue 3, March 2015 1 ISSN 2250-3153
- [12] N.Sivaramakrishna, Ch.Kasi Ramakrishna Reddy," *Hybrid Power Generation through combined solar – wind power and modified solar panel* " International Journal of Engineering Trends and Technology (IJETT) - Volume4Issue5- May 2013
- [13] Ashok Upadhyay , Arnab Chowdhury , " *Solar Energy Fundamentals and Challenges in Indian restructured power sector* ", International Journal of Scientific and Research Publications, Volume 4, Issue 10, October 2014 1 ISSN 2250-3153
- [14] Altab Hossain, Ramesh Singh, Imtiaz A. Choudhury, Abu Bakar, " *Energy efficient wind turbine system based on fuzzy control approach* ", 5th BSME International Conference on Thermal Engineering, SciVerse Science Direct, Procedia Engineering 56 (2013) 637 – 642

[15] PinnantiSravanthi, RameshBanothu, " *Design and analysis of Pelton Wheel Bucket* ", SSRG International Journal of Mechanical Engineering (SSRG-IJME) – volume 2 Issue 9 – September 2015, ISSN: 2348 – 8360

[16] Web Link : <https://www.elprocus.com/solar-charge-controller/>

[17] *The Authoritative Dictionary of IEEE Standards Terms, Seventh Edition*, IEEE Press, 2000, ISBN 0-7381-2601-2, page 588

[18] Web Link : <http://www.pvc.org/en/p/pvcs-physical-properties>

[19] Web Link : <http://www.alternative-energy-tutorials.com/energy-articles/wind-turbine-blade-design.html>

[20] Ilyas Shaikh, Danish Jahagirdar, Prof.Nawaz Motiwala "Design and fabrication of domestic wind turbine", International journal of innovations in engineering and technology, Volume 4, Issue 2, Feb.-2017

[21] Ashlesha Kothavale, Sonal Salunkhe, Pooja Wadkar, Prof.Nawaz Motiwala " *Design and fabrication of domestic hydro turbine*" International Journal of Latest Technology in Engineering, Management & Applied Science (IJLTEMAS) Volume VI, Issue III, March 2017 | ISSN 2278 - 2540

