

PROSPECTUS 2020-21

We Do All That Is Required To Be Done For YOU!!!

Navi Mumbai  
International  
Airport



Anjuman-I-Islam (Headquarters)

Proposed Hostel



D.T.E.  
Institute Code  
3439

# ANJUMAN-I-ISLAM'S KALSEKAR TECHNICAL CAMPUS

ACCREDITED BY NAAC

Approved by: All India Council for Technical Education (A.I.C.T.E.), Council of Architecture and Pharmacy Council of India, New Delhi, Recognized by: Directorate of Technical Education (D.T.E.), Government of Maharashtra and Affiliated to: University of Mumbai.  
SCHOOL OF ENGINEERING & TECHNOLOGY | SCHOOL OF ARCHITECTURE | SCHOOL OF PHARMACY

## **(Late) Haji Abdul Razzak E. Kalsekar: A TRUE VISIONARY**



(16 July 1931 - 10 August 2015)

**Philanthropist & Pillar of Strength for Anjuman-I-Islam's Kalsekar Technical Campus, New Panvel**

Haji Abdul Razzak Esmail Kalsekar, fondly remembered as 'Haji Saheb' was a true idealistic visionary. His Clarion call to society "Quality Education is Mandatory for All" truly reflected his purity of thoughts.

His dedicated efforts to empower and enrich the society were based on the strong belief that Education is the pillar of any healthy society and only through Education can we eliminate the evils of poverty and disparity and build an equitable society.

He was a man who didn't believe in just giving charity to the needy, instead he empowered them strengthen hands through EDUCATION, so that they can earn with dignity and serve the society.

*"You carried us in your arms, cradled us in your heart.  
You are now with the Protector,  
You will always remain in our Prayers."*

*Lives of Great men all remind us  
We can make our lives sublime,  
And departing, leave behind us,  
Footprints in the sands of Time.*

*You came into our lives,  
And left footprints in our hearts.  
And we will never, ever be the same.*

A humble tribute in gratitude,



**ANJUMAN-I-ISLAM'S  
KALSEKAR TECHNICAL CAMPUS**

New Panvel, Navi Mumbai-410 206

SCHOOL OF ENGINEERING & TECHNOLOGY | SCHOOL OF ARCHITECTURE | SCHOOL OF PHARMACY



**DR. ZAHIR I. KAZI**  
President, Anjuman-I-Islam

# Anjuman-I-Islam

## A Proud Heritage

147 Years of Service in Nation Building



From modest beginnings, Anjuman-I-Islam has flowered into singular institution, unsurpassed in its efforts to spread education to the marginalized sections of the society.

Anjuman-I-Islam has over a period of time, since its inception, grown by leaps and bounds, continuing to give quality education to its students. Today it runs **97 institutions** and at a time approximately **one lakh ten thousand students** derive benefits from the education imparted by these institutions. It has about 3000 teaching and administrative staff who make these efforts a success.

Anjuman-I-Islam is a leading educational conglomerate and social organization of India, **established in the year 1874**, by a group of visionaries led by **Justice Badruddin Tyabji**. Its first heritage structure came on the piece of land donated by Mr. Mohammed Ali Roghay. The Founders of Anjuman-I-Islam proactively participated in India's freedom struggle and established Anjuman-I-Islam as a symbol of Secularism and National Integration. It was also the beginning of a movement to support community's advancement in education and social standing.

Today, after **147 years**, Anjuman-I-Islam Trust runs under the dynamic leadership of **Dr. Zahir I.Kazi**. **He is the radiologist by profession**. Anjuman-I-Islam has numerous Institutions from K.G (kinder garden) to diploma in Engineering, graduation and post-graduation in Engineering, pharmacy, Architecture, Unani Medicine, Law, Arts, Commerce, economics, Hotel Management and catering, Management studies, Home Science and Ph.D. in Engineering and Urdu across Maharashtra in various cities like, Mumbai, Navi Mumbai, Raigad, Pune, Solapur, Panchgani etc.



*Over the years, many national and International eminent personalities*

*visited Anjuman-I-Islam and applauded its Secular Credentials in National Integration.*

**Kudos to Final Year Toppers 2019**

*Civil Engineering*



**Khan Fathima Israr**  
First Rank (CGPI-8.86)



**Poshekar Anas Mohd Amin**  
Second Rank (CGPI-8.71)



**Maddakari Tahmeena Abbas Ali**  
Third Rank (CGPI-8.59)

*Computer Engineering*



**Sardar Sobhya Md Ibrahim**  
First Rank (CGPI-8.89)



**Malbari Sabiya Abdul Rashid**  
Second Rank (CGPI-8.48)



**Shaikh Almas Javed**  
Third Rank (CGPI-8.35)

*Electrical Engineering*



**Mulla Rumana Najeeb**  
First Rank (CGPI-8.91)



**Shaikh Maseera Ismail**  
Second Rank (CGPI-8.72)



**Khan Mohd Sarfaraz Mohd Noor**  
Third Rank (CGPI-8.62)

*Electronics & Telecommunication Engineering*



**Sayyed Tazeen Aslam**  
First Rank (CGPI-8.36)



**Ansari Mohd Arham Mateen**  
Second Rank (CGPI-8.11)



**Khan Kulna Sikander**  
Third Rank (CGPI-7.94)

*Mechanical Engineering*



**Sandhi Taha Mastan**  
First Rank (CGPI-8.96)



**Singh Vishal Tajbahadur**  
Second Rank (CGPI-8.88)



**Bairagdar Hasnain Munir**  
Third Rank (CGPI-8.83)

*School of Architecture*



**Shaikh Shifa Ismail**  
First Rank (CGPI-8.11)



**Shaikh Zaara Abdussalam**  
Second Rank (CGPI-7.85)



**Mulla Azad Mohd Rafique**  
Third Rank (CGPI-7.81)

*School of Pharmacy*



**Nayab Mohd Asadullah**  
First Rank (CGPI-8.33)



**Khan Saleha Riyaz Ahmed**  
Second Rank (CGPI-8.12)



**Khan Tanveer Alam**  
Third Rank (CGPI-7.81)

**Degree Distribution Ceremony  
on behalf of University of Mumbai**



First Convocation Programme of AIKTC was held on 14 February, 2016 in presence of Chief Guest Dr. Zahir Kazi (Hon. President, Anjuman-I-Islam), Guest of Honor Dr. Maqsood A. Khan (Registrar, University of Mumbai)



Second Convocation Programme of AIKTC was held on 9 March, 2017 in presence of Dr. Zahir Kazi (Hon. President, Anjuman-I-Islam), Chief Guest Mr. Zafar Sarehswala (Chancellor, Maulana Azad National Urdu University, Hyderabad), Guest of Honor Mr. Mohammed Wajihuddin (Senior Journalist, Times of India)



Third Convocation Programme of AIKTC was held on 25 March, 2018 in presence of Dr. Zahir Kazi (Hon. President, Anjuman-I-Islam), Chief Guest, Mr. Mukhtar Abbas Naqvi (Union Minister for Minority Affairs), Guests of Honour, Dr. A. Subhash Babu and Dr. V. Jothiprakash (both, Professors-IIT Bombay).



Fourth Convocation Programme of AIKTC was held on 04 May, 2019 in presence of Dr. Zahir Kazi (Hon. President, Anjuman-I-Islam), Chief Guest, Mr. Prashant Thakur (Chairman, CIDCO, Navi Mumbai & MLA Panvel), Guests of Honour, Mr. Dhananjay Bendre (Sr. Director & Head of India Consulting Business, Oracle Consulting Ltd.)

KUDOS TO OUR ACHIEVERS



1st prize won by Aditi Chorge at Chem-o-Chrome @ VESCOP, Chembur



1st Prize won by Alish Khan, Kahaf Sayyed, Saif Khan, Osama Khan in Techno Philia V2.0-Sculpt The Steel @ MHSSCE, Byculla



1st prize won by Ammarah Ahmed, Aditya Bhat & Sameer Gazali in Techno Quiz Contest @ MHSSCE, Byculla



1st prize won by Mr. Akbar Dudhniwala @ PCERF Padmeshri B. Shirke Vidyarti Award 2019



2nd prize won by Sayed Mohd Kazim Mehdi in Hack-Pro-Tech Hackaton @ IEEE PEC



2nd prize won by Uzma Qureshi at Chem-o-Comedy @ VESCOP, Chembur



2nd Prize won by Shamshad Shaikh, Faez Ahmed and Afif Pallavkar in Techno Quiz Contest @MHSSCE, Byculla



2nd prize won by Sayed Sufiyan, Huzaib Mulla, Amaan Ahmed, Saif Shaikh at IETE Innovation Competition - 2019 @ Shah Anchor College of Engg., Chembur



Best Paper Award-Runner Up won by Asif Sayyed, Faizan Shaikh, Mohd. Akbar Shaikh, Mohd. Faizan Shaikh @ BVCOE, Navi Mumbai



3rd prize received by Zainab Khan & Shifa Momin for poster presentation @ UDAAN Fest-University of Mumbai



3rd prize won by Aryan Lakdawala in Squad Tech Hunt-2020 @ Squad Infotech Pvt.Ltd.



Team FARK3YT was amongst Top 12 teams in Schneider Go Green 2020 Competition organised by Schneider Electric



Secured 1549 position in India in Discovery Challenge @ Scalar Academy



62nd position out of 19,000 was secured by Faruk Mujawar in Internshala's campus ambassador program - Internshala Student Partner



Best Anchor Award received by Amina Hajwani @ UDAAN Fest, University of Mumbai

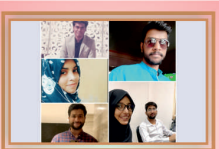

Saqub Momin, Pritesh Pal, Neha Siddiqui, Zaid Chougale, Najeen Sayed, Hozefa Kothari, Founders of Kodecraft



Mr. Afraz Rajiwate Founder of Modern Solutions



Dr. Mohd. Asif Gandhi Published Book How do Green Supply Chain Practice impact Green Supply Chain Performance



Appointed as Mentor Startup India to Prof. Awab Fakih by Ministry of Commerce and Industry, Government of India



Youth Teaching icon award received by Prof. Awab Fakih in International Education Symposium and Award 2019



Best Teacher Award received by Prof. Aamir Sayed @ Anjuman-I-Islam, Mumbai



Best Teacher Award received by Prof. Saba Shaikh @ Anjuman-I-Islam, Mumbai



Best Teacher Award received by Prof. Maria Lal @ Anjuman-I-Islam, Mumbai

# Ignite the Passion within You!

Dear aspiring student,

Welcome to Anjuman-I-Islam's Kalsekar Technical Campus (AIKTC), the most modern and high-tech educational campus of Navi Mumbai. AIKTC came into existence by the progressive approach and efforts of Anjuman-I-Islam, the foremost prestigious educational and social organization of India established 147 years ago.

We proudly acknowledge the dreams of the stalwarts who were part of the freedom struggle of India, realizing the need of an education system during the British rule. Due to their far sighted vision, Anjuman-I-Islam on behalf of its 97 institutions and one lakh ten thousand students, fulfils the educational requirement of the most underprivileged sections of the society today. We wish to expand the magnitude of Anjuman-I-Islam by providing quality education at lowest possible cost and ensuring that no student is deprived of education due to lack of finance.

Recently, Anjuman-I-Islam was conferred upon the prestigious Sir Syed Excellence National Award by Aligarh Muslim University (AMU) on 17th October 2020 proudly commemorated as Sir Syed Day at a virtual ceremony. Anjuman-I-Islam was awarded for its exemplary efforts and contributions in the field of education among the Muslims and marginalized sections of the society. At AIKTC, you will have the pleasure of experiencing quality education through its world class infrastructure and diligent faculties equipping you with the latest trends and practices of the industry to keep you going on the path of professional success. The college is NAAC accredited and offers all kinds of government scholarships and financial aid to the eligible ones.

**We believe, education is about creating LEADERS for tomorrow...**

Do you wish to be a Leader??? If YES, then welcome to AIKTC.

**DR. ZAHIR I. KAZI**  
Hon. President, Anjuman-I-Islam



Dr. Zahir I. Kazi, Hon. President AI, had the honour of meeting with our Dynamic Prime Minister, Shree Narendra Modiji.

Dr. Zahir I. Kazi President of Anjuman-I-Islam recently met veteran actor and legend Mr Amitabh Bachchan where he endorsed his remarks for our organization serving for the last 145 years. A brochure is being handed over to him. Also Mr Big B gifted our President a book written by Mr Khalid Mehamood & Ms. Jaya Bachchan on his 70th Birth Anniversary. One more great gesture shown to our President by Big B is that he handed over an Album of his portrait paintings created by leading painters including M.F. Hussain released during his 75th Birthday. Long live all with a mission to promote everything good for entire Humanity.



Dr. Zahir Kazi, Hon. President AI, received the **National Education Award** at an event organized by ABP News at Taj Lands End

## Forge Ahead

Dear student,  
Hope you are safe and secure during this pandemic.

I congratulate you for successfully passing your qualifying exams during COVID-19 pandemic. Your continued dedication towards education is phenomenal. Today, you are capable enough to find the right career choices and admit yourself into a college like AIKTC for higher education, thanks to the indispensable devotion of organizations like Anjuman-I-Islam.

My father, Late Haji Abdul Razaq Kalsekar Sahab affirmed that the noblest deed is to educate someone whose impact will never fade away in-fact it will keep paying off till his last breath. I whole heartedly appreciate and acknowledge Anjuman-I-Islam for providing affordable quality education for the last 147 years.

Amongst the various institutions of Anjuman-I-Islam, AIKTC offers advanced system of educating its students to transform them into a competent and confident technical professional. Since its inception, AIKTC is continuously refining its system and recently received accreditation from NAAC. We encourage you to explore newer opportunities, follow your dreams and convert them into reality.

We believe that a right step in the right direction, at the right time and right place can change the course of entire life.

I pray to the Almighty for your brighter future and remarkable success.

**The reward of every good deed will always be better than what was offered.**



**MR. SALIM ABDUL RAZZAK KALSEKAR**

Chairman : A. E. Kalsekar Educational and Welfare Trust, Mumbai.





## Dream Big!

Dear student,

Greetings from AIKTC, an amazing integrated technical campus for the aspiring technocrats.

Technical education is the most important need of the hour where students can shape their ideas into action and be the leaders of the industry. Let us move ahead from the general courses to the most direct technical education system where job based skills are imparted.

We are living in the age of Science & Technology wherein the whole kit and caboodle surrounding us is based on some technical traits or applications. Our pattern of life has changed completely in comparison to the way people lived 50 years ago. Due to automation, our way of sustaining livelihood has been changed from our bare hands to the usage of modern machines. So, now the time has come for us to train the young minds as per the technical requirements and expectations of the present.

A technical campus like AIKTC moulds dedicated students into Architects, Engineers and Pharmacists for creating and functioning the modern system and technologies as per the global standards. We have the best human resources who enjoy teaching and training the AIKTCians into skilled manpower of the industry. Due to fierce competition of employment, we also encourage and promote incubation and start-ups to make our students self-reliant (ATMA-NIRBHAR).

We also, take special care in educating the under privileged or the marginalised sections of the society and at AIKTC nothing will stop you from being an employable graduate. Anjuman-I-Islam through AIKTC has envisioned to drive excellence in technical and professional education for making you the best.

It is said that **people without goals, work for people who have goals...**

So, if you have realized your goal; then AIKTC is for you.

A handwritten signature in black ink, appearing to read 'G. A. R. Shaikh'.

**G. A. R. SHAIKH**

Hon. General Secretary, Anjuman-I-Islam



# Inspiring a Global Generation!

My dear student,

Hearty welcome to Anjuman-I-Islam's Kalsekar Technicial Campus. It is one of the highly acclaimed institutions in the history of Anjuman-I-Islam. From the beginning of this campus, we are remarkably successful in imparting quality technical education through sincere and honest practices, thus building an ambit of great work culture.

We are continuously upgrading our teaching-learning system by imparting innovative teaching methodologies both online and offline. During this ongoing pandemic, we have ensured excellent delivery of concepts by the faculties through online portals and special care is taken during practical hours through virtual laboratories. We keep ourselves in tune with the changing dynamics of the industry so as to develop time tested techniques, values and experiences. Our campus is accredited by NAAC and our next step is to get all our programs accredited by NBA for various research opportunities.

We enable every student to explore new realms of knowledge, skills, attitude and wisdom. In this campus, we produce knowledgeable technical professionals having right attitude, character and inspiring mind, thus making them lifelong learners. For this, we do all that is required to be done for you.

By the time you complete your tenure in this campus, you get equipped to tackle every technological challenge or otherwise, with a view to provide solutions.

Wishing you highly rewarding academic years ahead and the most memorable stay on the campus.

**"With you.... till you do not need us in any way".**

**BURHAN HARRIS**  
Hon. Executive Chairman,  
Board for Institutions in  
Navi Mumbai,  
Anjuman-I-Islam



# A Decade of Innovative Teaching, Leading & Learning

## Refine & Define, Reach & Teach

If you believe in yourself and is ready to work hard i.e. push yourself 1% extra compared to others, then you are at the right place i.e. AIKTC. We are providing excellent technological education to our students for being successful in the continuously developing world. It is our innate pride to have been functioning under Anjuman-I-Islam, Mumbai imparting quality education to develop knowledge, skills, and characters which are committed to human developmental goals and global well-being.

The New Education Policy highlighted the need and benefits of multidisciplinary institutions, AIKTC offers multidisciplinary technical education i.e. Architecture, Engineering and Pharmacy since 2010. Our integrated campus provides increased access, even-handedness, and inclusion of the various challenges and opportunities of the future to the students. We have the latest infrastructure wherein our students learn experientially through various technical devices and tools at campus or virtually. With teaching, our faculties continuously involve the students in research-intensive activities to develop their critical thinking, collaboration and problem-solving skills; so that after graduating, they can have their own start-up and become atma-nirbhar.

Our students are academically rigorous, integrated and aligned with the needs of industry. We also emphasise on inculcating universal human values, professional development and right attitude to fortify your potential to thrive successfully.

Wishing you a happy, engaging and successful learning experience at AIKTC & be an integral part of Innovative Teaching & Exuberant Learning (iTeL).

**We must know enough to know that we do not know!**

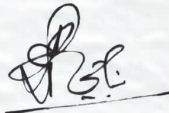

**Dr. ABDUL RAZAK HONNUTAGI**  
 Founding Director,  
 AIKTC, New Panvel.

**IF I KNEW  
 THEN  
 WHAT I KNOW  
 NOW!**

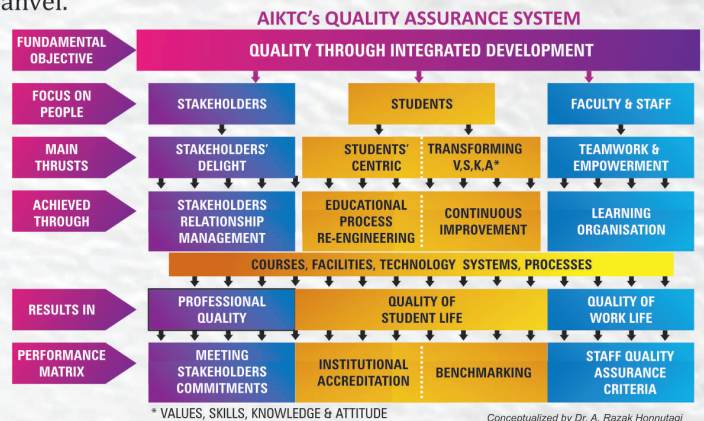

## AIKTC's SCHOOL OF ARCHITECTURE



Greetings!!!

What is architecture ? is a question particularly asked by students who are looking for architecture as their future career. For me architecture is about happiness. The happiness of creation, that comes from within. A commitment to yourself to make somebody happy through our own creativity. Creativity is a science, that extracts realism from abstraction. Abstractions takes place when one wants to express the process of thinking and interpretation of the contextual background. Architecture thus is that science which bridges the gap between abstraction and reality through creative critical mind mapping. It is a science which turns

imagination into design elements which caters to the future. Understanding culture, nature and the contextual background which can be expressed through different ideas of built forms is what is construed in the students by our enthusiastic faculty at School of Architecture. Here at SoA we inculcate a positive attitude, sense of responsibility towards mankind and nature and respect to our tradition and culture in the student through our collaborative teaching methodology. Our students are our biggest assets and we nurture them with great care and work constantly towards their futuristic goals through our best possible teaching abilities. We try and promote a school of thoughts which makes the student able to face all the challenges ethically research and become a creative thinker for inventing sensitive designs. Architecture thus becomes the most interesting career option which works through a process leading towards the reality at AIKTC, School of Architecture.

***Come join us for life changing fun based learning experience of design and creativity!***

**PROF. RAJ MHATRE**

I/c Dean- School of Architecture, AIKTC, New Panvel.

---

## AIKTC's SCHOOL OF PHARMACY



Greetings!!!

Healthcare and the profession of Pharmacy is constantly evolving globally. Pharmacists are playing a significant role in general health care, by contributing to greater life expectancy and better quality of life

The responsibility of a pharmacist therefore increases dramatically as there is an exponential increase in disease burden on society.

At AIKTC School of Pharmacy, we believe in producing multifaceted health care professionals with a strong commitment and deep desire to contribute to the society. Established in the year 2011, the institute is being nurtured with utmost care by the team of dedicated

faculty members and supporting staff with a vision to reach a new heights in educational achievement. Our dedicated faculty help and inspire students to achieve their goals

***I invite you to be a part of this school of excellence to achieve landmark in pharmacy education.***

**DR. SHARIQ SYED**

I/c Dean- School of Pharmacy, AIKTC, New Panvel.

*The Dynamic Management Team That Spurs Us On To Success  
The Esteemed Office Bearers of Anjuman-I-Islam*



(L-R) : Mr. Aqil Yusuf Hafiz, Dr. Shaikh Abdullah, Mr. Mushtaq Antulay, Dr. Zahir I. Kazi,  
Mr. Mohd. Hussain Patel, Mr. G. A. R. Shaikh, Mr. Moiz Miajiwala, Mr. Moinul Haq Choudhury

### ANJUMAN-I-ISLAM'S OFFICE BEARERS

DR. ZAHIR KAZI	Hon. President
MR. MUSHTAQ ANTULAY	Hon. Vice President
MR. MOHD. HUSSAIN PATEL	Hon. Vice President
DR. SHAIKH ABDULLAH	Hon. Vice President
MR. MOIZ MIAJIWALA	Hon. Treasurer
MR. G. A. R. SHAIKH	Hon. General Secretary
MR. AQIL YUSUF HAFIZ	Hon. Joint Secretary
MR. MOINUL HAQ CHOUDHURY	Hon. Joint Secretary



MR. BURHAN HARRIS

### BOARD FOR INSTITUTIONS IN NAVI MUMBAI

MR. BURHAN HARRIS		Hon. Executive Chairman	
MR. ALI M. SHAMSI	Member	MR. IQBAL KAWARE	Member
MR. RAFIQ NAIK	Member	DR. NAZIR JUVALE	Member
MR. SHOAIB JAMKHANAWALA	Member	MR. IMRAN FURNITUREWALA	Member
MR. WAGHOO ABDUL RAZAK	Member		

### BOARD OF GOVERNORS FOR A.I.K.T.C.

DR. ZAHIR I. KAZI	Chairman
MR. G. A. R. SHAIKH	Member
MR. BURHAN HARRIS	Member
MR. ASIF DADARKAR	Member
DR. YASIN RASHID KAZI	Member
MR. V. R. SHARIFF	Member-Industrialist
DR. AJEET SINGH	Member-AICTE(WRO)
Member from University of Mumbai	Nomination Awaited
DR. ABHAY WAGH	Member- DTE (Ex-officio)
Member from Govt. of Maharashtra	Nomination Awaited
DR. ABDUL RAZAK HONNUTAGI	Member- Secretary
DR. SHARIQ SYED	Member- Faculty AIKTC-SoP
PROF. RAJ MHATRE	Member- Faculty AIKTC-SoA
DR. RAJENDRA MAGAR	Member- Faculty AIKTC-SoET
PROF. POONAM MHATRE	Member- Faculty AIKTC-SoA
PROF. PRAJAKTA WADWALKAR	Member- Faculty AIKTC-SoA
PROF. ZAKIR ANSARI	Member- Faculty AIKTC-SoET
PROF. ABUSUFYAN SHAIKH	Member- Faculty AIKTC-SoP

### COLLEGE DEVELOPMENT COMMITTEE (CDC)

DR. ZAHIR I. KAZI	Chairman
MR. G. A. R. SHAIKH	Member
MR. BURHAN HARRIS	Member
PROF. ZAKIR ANSARI	Member
DR. M ASIF GANDHI	Member
PROF. AJAZ AHMED	Member
PROF. POONAM MHATRE	Member
MR. SAMEE DESHMUKH	Member
PROF. A. SUBHASH BABU	Member
MR. MARUTI PAWAR	Member
DR. FARUK KAZI	Member
MR. V.C. MHATRE	Member
DR. RAJENDRA MAGAR	Member
MR. NOOR-UL-AMIN MIR	Member
MR. AKBAR DUDHNIWALA/MS. SHAGUFTA SHAH	Member
DR. SHARIQ SYED	Dy. Member-Secretary
PROF. RAJ MHATRE	Dy. Member-Secretary
DR. ABDUL RAZAK HONNUTAGI	Member- Secretary



ANJUMAN-I-ISLAM'S  
**KALSEKAR TECHNICAL CAMPUS**  
 New Panvel - 410 206.

## AIKTC-BUILT AROUND YOUR AMBITIONS

**AIKTC: A Campus poised for Quality Excellence!**

- ▶ Established in 2011.
- ▶ Spread over 10.50 acres with more than **3.15 lakh sq.ft.** of built up area and still expanding.
- ▶ In spite of being a Minority Institution, it has a **spectacular culture of secular credentials.**
- ▶ An **outstanding technological campus** having world class laboratories and ultra modern facilities.
- ▶ **Par Excellence in Education, Research & Practice** in Engineering and Technology, Pharmacy and Architecture.
- ▶ **Developing students into a complete Human Resource** for industry and society at large.
- ▶ Students here are **lifelong learners capable of adapting** to an ever changing technological world.

## AIKTC- FOCUSED ON YOUR SUCCESS



Bonhomie, Fuerza,  
 Mash-up, Algorithm

World Class Auditorium  
 & Media Centre

MHRD Projects  
 Unnat Bharat Abhiyan  
 for Rural Development

Social Innovation,  
 Invention & Incubation

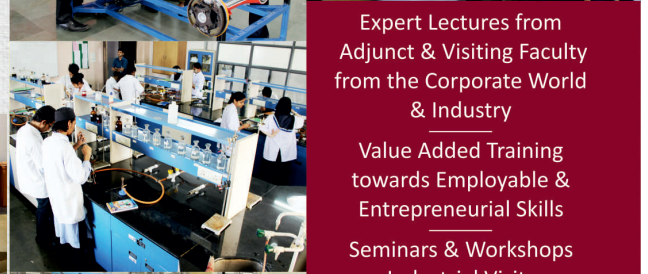
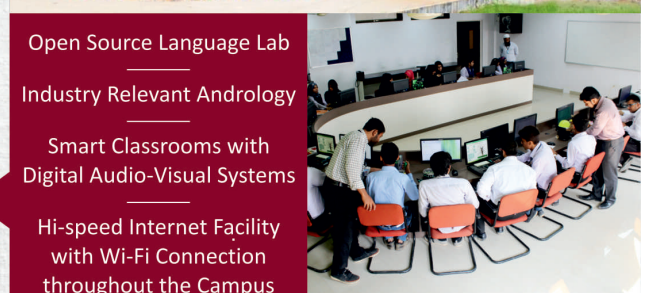

Open Source Language Lab

Industry Relevant Andrology

Smart Classrooms with  
 Digital Audio-Visual Systems

Hi-speed Internet Facility  
 with Wi-Fi Connection  
 throughout the Campus

Scholarships/  
 Financial Assistance  
 to Students

Expert Lectures from  
 Adjunct & Visiting Faculty  
 from the Corporate World  
 & Industry

Value Added Training  
 towards Employable &  
 Entrepreneurial Skills

Seminars & Workshops  
 Industrial Visits

Modern Simulation Labs

Hi-tech Workshops

Training & Placement Cell

Participation in Inter & Intra  
College Technical Exhibitions

Human Resource Centre for  
Achievements, Reformation  
& Excellence (HR-CARE)

Students' Amenities Centre  
and Cafeteria

Centre for Peace & Spirituality

Knowledge Resource &  
Research Centre (KRCC)

Modern Library with  
e-journals and Digital Access



### **Vision**

*"To be the most sought after Technical Campus that others would wish to emulate."*

### **Mission**

*Creating Exuberant Technical Professionals*

### **Mission Elements**

- *To implement the Outcome Based Education (OBE) Model to conform to our belief "Students Learn What We Teach".*
- *To encourage and upgrade teachers for innovative teaching skills, research and practice.*
- *To provide necessary facility, machinery, equipment, atmosphere and ambience that would enable quality academics, research and practice.*
- *To create an eco-system for professional competition, lifelong learning and reward mechanism.*
- *To prepare and encourage students for societal welfare activities, higher studies, entrepreneurship, employment, research and innovations to become a complete Human Resource.*

## THE STRATEGIC PILLARS OF AIKTC

### ABILITIES

Leadership  
Teamwork  
Communication  
Decision Making  
Recognize and Manage change  
Work Effectively in Diverse & Multicultural Environments  
Synthesize Engineering, Business & Social Perspectives

### KNOWLEDGE DOMAIN

Science & Maths  
Engineering Fundamentals  
Analytical Skills  
Open Ended Design & Problem Solving Skills  
Multi-disciplinary within and beyond Engineering  
Integration of Analytical, Problem Solving & Design skills

### QUALITIES

Innovative  
Strong Work Ethics  
Ethically Responsible in a Global, Social, Intellectual and Technological Context  
Adaptable in a Changing Environment  
Entrepreneurial & Intrapreneurial  
Curious & Persistent Learners

To provide Educational Experiences that develop Students' knowledge areas, Abilities and qualities to enable them to identify needs and construct effective solutions in an economically, socially & culturally relevant manner.

AIKTC



SCHOOL OF ENGINEERING & TECHNOLOGY

**SoET**

## **BACHELOR OF ENGINEERING - B.E.**

About the Programme:

Engineering is the application of mathematics and scientific, economic, social, and practical knowledge in order to invent, innovate, design, build, maintain, research and improve structures, machines, tools, systems, components, materials, processes, solutions and organizations. The discipline of engineering is extremely broad and encompasses a range of more specialized fields of engineering, each with a more specific emphasis on particular areas of applied science, technology and types of application. AIKTC offers five programmes of Engineering and Technology at undergraduate, post graduate and doctoral level. Outcome Based Education (OBE) philosophy is implemented here.



# Bachelor of ENGINEERING

DTE Code : EN3439

Duration: 4 years

Intake: 420 seats



Admission & Eligibility Details on page 53



*New Courses since 2014*

**M.E. in**  
**Construction Engineering & Management**  
 Duration : 2 Years    Intake : 18 Seats

**Ph.D.**  
**in Civil Engineering**  
 Intake : 10 Seats



# DEGREE COURSES IN BACHELOR OF ENGINEERING

B.E. DTE Code : EN3439

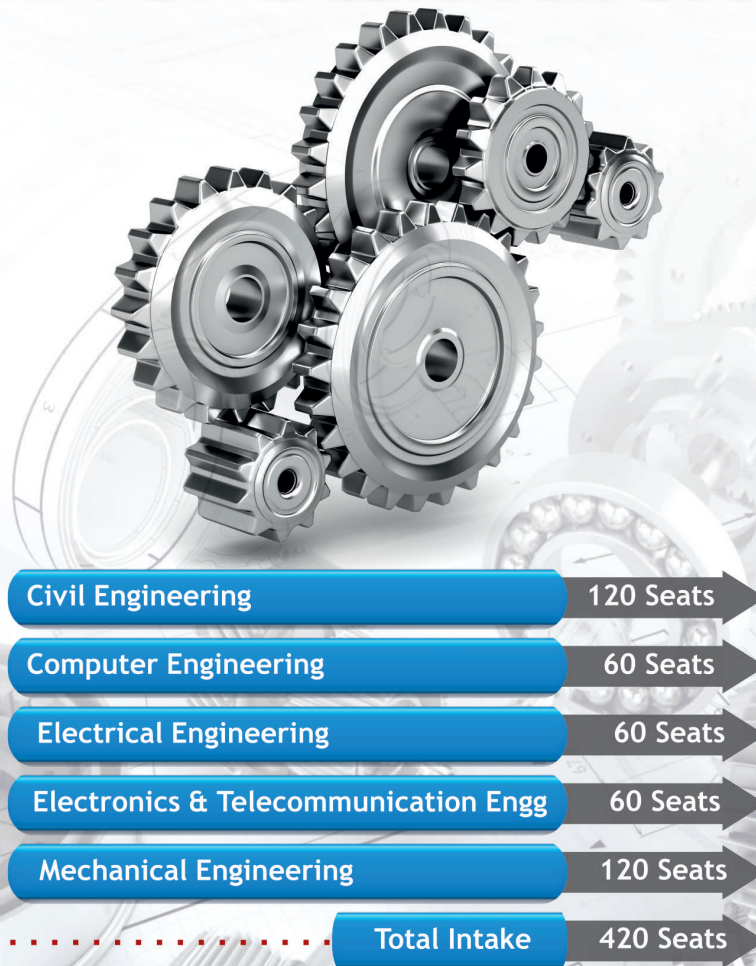



# CIVIL ENGINEERING



Fluid Mechanics Lab

**B.E.**  
Duration : 4 years  
Intake : 120 seats

**M.E.**  
(CONSTRUCTION ENGG. & MANAGEMENT)  
Duration : 2 years  
Intake : 18 seats

**Ph.D**  
Intake : 10 seats

DTE Code  
Shift I : 343919110



Transportation Lab



Concrete Technology



Geotechnical Lab

## Vision

To be the most sought after academic, research and practice based department of Civil Engineering that others would wish to emulate.

## Mission

Creating Exuberant Civil Engineering Professionals.

The Department of Civil Engineering boasts of state-of-the-art facilities with highly experienced and well qualified proactive faculty members. It has 10 laboratories well equipped with modern machinery, equipments and instruments necessary for testing, research and development. Students have consistently won 1st, 2nd and 3rd prizes at Tech Fests of both IIT Bombay and IIT Kanpur over the years. Their works were appreciated and approbated by the IITians. Post Graduation program in Construction Engineering and Management has commenced from 2014-15. The department has also been granted Ph.D. Research Center by the University of Mumbai from the year 2017-18.

## B.E. (CIVIL ENGG.) BATCH 2014-18



*A assortment of learning spaces and facilities at AIKTC is excellent, along with the strong interactive sessions with AIKTC's very dedicated, knowledgeable and experienced professors, enthusiastic for the subject matter of teaching, created a strong positive impact from academics to extra-curricular and projects, which helped me to stay focused to achieve my scoring 8.86 CGPI.*



**KHAN FATHIMA ISRAR**  
First Rank (CGPI-8.86)



**TEAM : CIVIL ENGINEERING**

(L-R): Row 1: Prof. Tehsin Kazi, Prof. Dada Patil, Dr. Rajendra Magar (HOD), Dr. Abdul Razak Honnutagi (Director), Prof. Dhaval Shah, Prof. Girish Mahajan, Dr. Prabha Joshi, Prof. Sayyedazara Jahagirdar. Row 2: Prof. Rohan Dasgupta, Prof. Prathamesh Gawade, Dr. Maheboobsab Nadaf, Prof. Fauwaz Parkar, Prof. Vedprakash Maralapalle, Prof. Shoukin Hawelikar, Prof. Firoz Nadaf. Row 3: Prof. Wasim Shaikh, Prof. Umesh Jadhav, Prof. Shivaji Sarvade, Prof. Junaid Maste, Prof. Irfan Nalband, Mr. Hasim Mulla. Row 4: Gulab Khatik, Mr. Rais Pawle, Mr. Shams Tabrez, Mr. Maqsood Patel, Mr. Sarfaraz Adhikari.



**Dr. Rajendra Magar (HOD)**

**Programme Curriculum Threads**

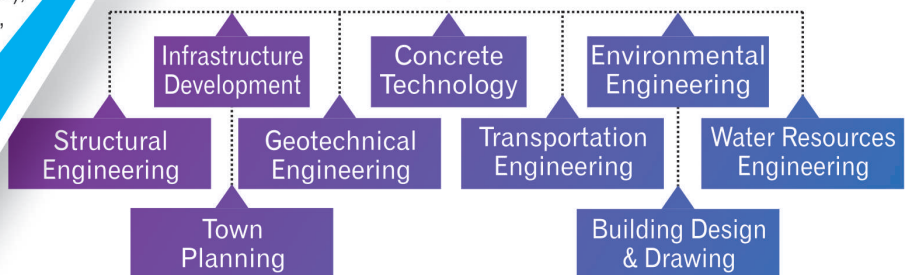

**Career Paths**

- ★ Structural Consultant
- ★ Transportation Consultant
- ★ Geotechnical Consultant
- ★ Environmental Consultant
- ★ Quantity Surveyor & Valuer
- ★ Surveyor

- ★ Construction Contractor
- ★ Town Planner & Urban Designer
- ★ Project Management Consultant
- ★ Water Supply & Sanitation Engr.
- ★ Research & Development in Allied Fields

- ★ State & Semi-Government Engineers
- ★ Public Sector Undertakings (PWD, CIDCO Irrigation Dept., MMRDA, MHADA, Indian Rlys)
- ★ many more....



Site Visit of Final Year students to Morbe Dam



Expert talk by Dr. Tarendra Lakhankar, Senior Scientist-CUNY CREST, The City University of New York



Campus Recruitment Training



# COMPUTER ENGINEERING

Duration : 4 years | Intake : 60 seats



Electronics & Signal Processing Lab

DTE Code  
343924510



Artificial Intelligence Lab



Cloud & Web Development Lab



Project Lab

## Vision

To be the most sought after academic, research and practice based department of Computer Engineering that others would wish to emulate.

## Mission

Creating Exuberant Computer Engineering Professionals.

Computer Engineering is a huge spectrum having various domains like Computer Programming, Information Analysis and Prediction, Networking and Data Security, Internet and World Wide Web, Software Programming Design and Development, etc. The world is advancing today at a rapid speed due to the use of computers in all fields of education, research, design and development. Programmers' Club (By the students and For the students) is a worthy initiative providing guided freedom to our students for their creative expression. Young, enthusiastic, energetic and responsible faculty, staff and the state-of-art infrastructure are the key assets here.



One of the most interesting stage in life that gives you an opportunity to explore is "college life phase". My experience at Kalsekar Technical campus was combination of good experiences, challenges and sometimes some bad experience. This college taught me one fundamental thing - life is unpredictable. It might be good, bad or weird but no matter what you have to go on. My teachers who have great skillset and extremely talented in their fields, I had not only learned academic but life lessons from them. I want to thank all of them without them i couldn't achieved all these amazing skills and knowledge.



**SARDAR SOBIYA MD IBRAHIM**  
First Rank (CGPI-8.89)



**TEAM : COMPUTER ENGINEERING**

(L-R): Row 1: Prof. Apeksha Gopale, Prof. Kumari Rajesh, Prof. Tabrez Khan (I/c HOD), Dr. Abdul Razak Honnutagi (Director), Prof. Nikhat Fatma Shaikh, Prof. Rehaal Qureshi. Row 2: Prof. Muhd S. Shamsi, Prof. Irfan Jamkhandikar, Mr. Shahnaawaz Qazi, Prof. Mukhtar Ansari, Prof. Javed Sheikh Khan, Prof. Mubashir Khan, Prof. Kalpana Bodke. Row 3: Prof. Abdus Salam, Mr. Vasimoddin Shaikh, Mr. Maviya Patel, Mr. Mohd. Arif Quraishi, Mr. Tufail Khan, Mohd. Nabeel Shaikh, Mr. Shahbaz Adhikar.



**Prof. Tabrez Khan (I/c HOD)**

**Programme Curriculum Threads**

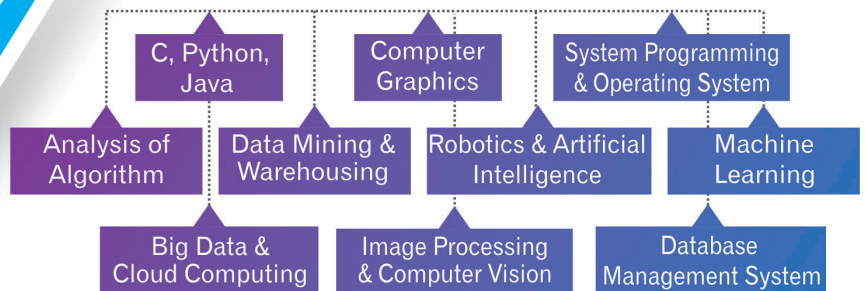

**Career Paths**

- ★ Data Scientist
- ★ Network Engineer
- ★ Web Developer
- ★ Software Developer
- ★ Systems Administrator
- ★ Security Specialist
- ★ Software Engineer
- ★ Database Administrator
- ★ Many More ....



PC Workshop



Python Bootcamp Diploma Certification Course by Programmers Club



National Level Hackathon-Algorithm 6.0

# ELECTRICAL ENGINEERING

Duration : 4 years

Intake : 60 seats



Electronics & Signal Processing Lab

DTE Code  
343929310



CS Lab



Project Lab



PSE Lab

## Vision

To be the most sought after academic, research and practice based department of Electrical Engineering that others would wish to emulate.

## Mission

Creating Exuberant Electrical Engineering Professionals.

The Department of Electrical Engineering offers a vibrant environment for undergraduate education and research, and is committed to the advancement of the frontiers of knowledge in electrical engineering, thus providing students with a stimulating and rewarding learning experience.

The modern, well-equipped laboratories are recognized for research work of faculty members, encompassing a wide gamut of sub-disciplines of electrical engineering in collaboration with researchers from other disciplines, from within and outside the institute. The department is strong with their senior faculty members who are experts in various fields of electrical engineering that include Power System Restructuring and Reforms & Digital Processing.





The education i received at electrical department (AIKTC) has helped me a lot to first of all give me an orientation of what I would like to do and secondly the practical approach providing me with valuable information and helping me every day in my career. I sincerely want to thank Prof. Syed Kaleem and Prof. Iftekar Patel for being a guiding light in my academic years.



**TEAM : ELECTRICAL ENGINEERING**

(L-R): Row 1: Prof. Syed Kaleem (I/c HOD), Dr. Abdul Razak Honnutagi (Director). Row 2: Shraddha Hule, Prof. Harshini Kunduru, Prof. Tahoora Qureshi, Prof. Iftekar Patel, Prof. Yakub Khan, Prof. Tanveer Hussain, Prof. Ankur Upadhyay. Row 3: Mr. Dastagir Shaikh, Mr. Zubair Antulay, Prof. Mohsin Khan, Prof. Vivek Tiwari, Mr. Mohd. Tayyab Alam, Mr. Majid Pathan.



**MULLA RUMANA NAJEER**  
First Rank (CGPI-8.91)



Prof. Syed Kaleem (I/c HOD)

### Programme Curriculum Threads

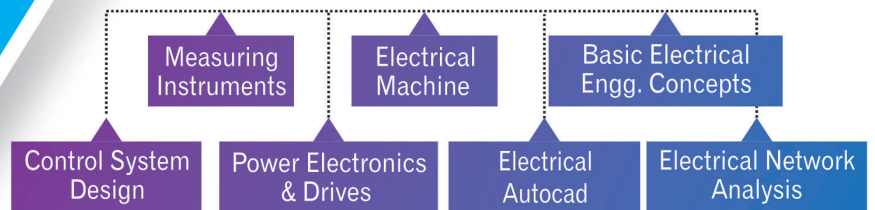

### Career Paths

- ★ Service Engineer
- ★ Maintenance Engineer
- ★ Quality Control & Quality Analyst
- ★ Power Engineer
- ★ Energy Auditors
- ★ State & Semi-Government Engineers
- ★ Electrical Consultancy
- ★ M.S.E.B. Engineers
- ★ Private Contractor
- ★ Railways
- ★ many more....
- ★ Planning Engineers

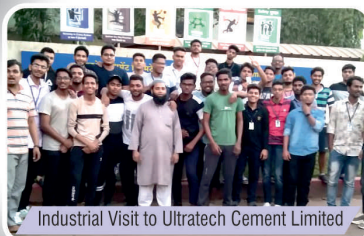

Industrial Visit to Ultratech Cement Limited



Expert Talk on Control System



Wiring Wizard Workshop

# ELECTRONICS AND TELECOMMUNICATION ENGINEERING

Duration : 4 years | Intake : 60 seats



Network Simulation Lab

DTE Code  
343937210



Analog Electronics Lab



Digital Electronics & Measurement Lab



Signal Processing Lab

## Vision

To be the most sought after academic, research and practice based department of Electronics and Telecommunication Engineering that others would wish to emulate.

## Mission

Creating Exuberant Electronics and Telecommunication Engineering Professionals.

Society relies on Electronics & Telecommunications for breakthrough in applications such as Satellites, Next Generation Mobile Phones, Air Traffic Control, etc. Employment opportunities for EXTC engineers are growing rapidly. They include manufacturing of audio and visual broadcasting and receiving equipments, interfaces, security devices, communication equipment, etc. Telecommunication has to be acknowledged as a vital ingredient for technology that is continuously growing by leaps & bounds. The department boasts of a dynamic team of faculty and staff dedicated to students' learning and engagement. It has signed MoUs with many industries such as Reliance Jio, Eduvance Pvt. Ltd., Centre of Excellence in Maritime & Ship Building (CEMS) etc.



*AIKTC provides their Students with modern Infrastructure and amenities and trains them to grab any opportunity. The Expertise here has always encouraged to excel in field of Technology and achieve a new height. It has always been a pleasure to be a part of A.I.K.T.C*



**SAYYED TAZEEN ASLAM**  
First Rank CGPI-8.36



Prof. Shaikh Afzal (I/c HOD)



**TEAM : ELECTRONICS & TELECOM ENGINEERING**

(L-R): Row 1: Prof. Afzal Shaikh (I/c HOD), Dr. Abdul Razak Honnutagi (Director), Prof. Mujib Tamboli. Row 2: Prof. Shahin Athavani, Prof. Bandanawaz Kotiyal, Prof. Chaya S, Prof. Geeta Desai. Row 3: Prof. Rahul Khadse, Mr. Zaid Bakshi, Prof. Rizwan Alvi, Mr. Imran Shaikh, Prof. Altaf Balsing.

**Programme Curriculum Threads**

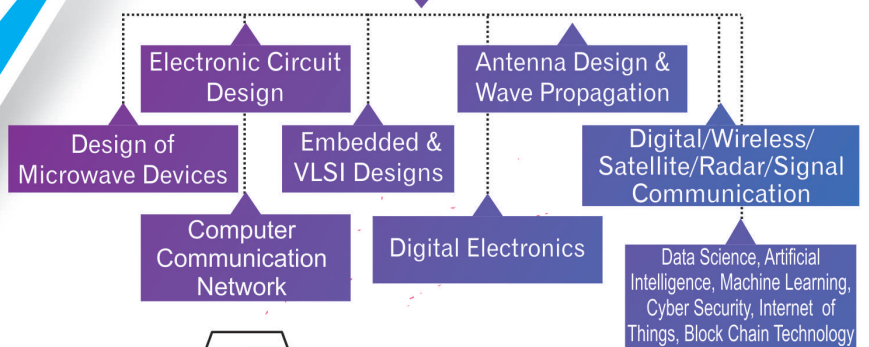

**Career Paths**

- ★ Telecomm Engineers
- ★ Service Engineers
- ★ Mobile Computing Engineers
- ★ Embedded System Engineers
- ★ PCB Designers
- ★ VLSI Designers
- ★ Electronic Circuit Engineers
- ★ Network Engineers
- ★ Many More ....





# MECHANICAL ENGINEERING

Duration : 4 years     Intake : 120 seats



CAD/CAM Lab

DTE Code  
343961210



TOM & Vibration Lab



Mechatronics Lab



Automobile & ICE Lab

## Vision

To be the most sought after academic, research and practice based department of Mechanical Engineering that others would wish to emulate.

## Mission

Creating Exuberant Mechanical Engineering Professionals.

The role of a mechanical engineer is to take a product from an idea to the marketplace. To accomplish this, the mechanical engineer must be able to determine the forces and thermal environment that a product, its parts, or its subsystems will encounter; design them for functionality, aesthetics, and durability; and determine the best manufacturing approach that will ensure operation without failure. Mechanical engineers play key roles in a wide range of industries including automotive, aerospace, biotechnology, computers, electronics, microelectromechanical systems, energy conversion, robotics and automation, and manufacturing. The American Society of Mechanical Engineers (ASME) currently lists 36 technical divisions, from advanced energy systems and aerospace engineering to solid-waste engineering and textile engineering. The breadth of the mechanical engineering discipline allows students a variety of career options beyond the industries listed above. Regardless of the particular path they envision for themselves, a mechanical engineering education empowers students with creative thinking skills to design an exciting product or system; analytical tools to achieve their design goals; the ability to overcome all constraints; and the teamwork needed to design, market, and produce a system. These valuable skills can be applied to launch careers in many other fields, such as medicine, law, consulting, management, banking, and finance.

B.E. (MECH. ENGG.) BATCH 2014-18



*I will Forever be grateful to be a Student of AIKTC!  
This institute gives a tremendous opportunity for students to broaden their knowledge. Definitely, AIKTC have the most interactive, inspiring, compassionate and dedicated faculties. I would like to owe my sincere gratitude to all the professors of this institute.*



**SANDHI TAHA MASTAN**  
First Rank (CGPI-8.96)



**TEAM : MECHANICAL ENGINEERING**

(L-R): **Row 1:** Prof. Afaqahmed Jamadar, Prof. Zakir Ansari (I/c HOD), Dr. Abdul Razak Honnutagi (Director), Dr. Mohd. Asif Gandhi. **Row 2:** Prof. Nafe Momin, Prof. Shakil Tadavi, Prof. Javed Kazi, Prof. Aslam Hirani, Prof. Nawaz Motiwala, Prof. Altamash Ghazi, Prof. Saad Shaikh. **Row 3:** Mr. Nadeem Hajwane, Prof. Arshad Quraishi, Prof. Rahul Thavai, Mr. Nisar Shaikh, Mr. Faiyaz Khan, Prof. Zia Momin, Mr. Faiz Sayyed.



**Prof. Zakir Sajid Ansari (I/c HOD)**

**Programme Curriculum Threads**

Design Engineering	Thermal Engineering	Manufacturing Engineering	Interdisciplinary
Strength of Material	Thermodynamics	BASIC WORKSHOP PRACTICE I & II	Industrial Electronics
CAD Modelling & CAD/CAM_CNC, 3D Printing	Fluid Mechanics	PRODUCTION PROCESSES	Python Programming
Kinematics & Dynamics of Machinery	Thermal Engineering	Machine Shop Practice	Business Communication & Ethics
Finite Element Analysis	Turbo Machinery	Mechanical Measurement & Control	Automation & Artificial Intelligence
Machine Design & Design of Mechanical System	Heating Ventilation & Air Conditioning	Logistics and Supply Chain Management	Soft Skills
Product Design & Development	Renewable Energy Systems	Operational Planning & Control	Internet of Things
Product Lifecycle Management		Quality & Maintenance Engineering	Automotive Power System
Design of Experiment			Vehicle System



**Career Paths**

- ★ Aerospace Industry
- ★ Defence Industry
- ★ Railways
- ★ Automotive Industry
- ★ Marine Industry
- ★ Utilities
- ★ Chemical Industry
- ★ Material and Metal Industry
- ★ Many More ....



Industrial Visit to Micro Turners Group in Biddi, Chandigarh



Diploma Certification Course on ANSYS Workbench

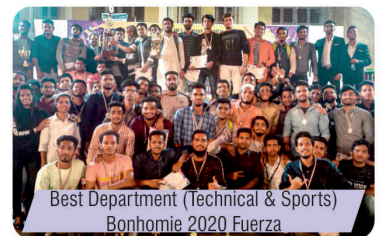

Best Department (Technical & Sports) Bonhomie 2020 Fuerza

# HUMANITIES AND APPLIED SCIENCES (HAS)



Induction Program of First Year Students

Institute  
DTE Code  
3439



Chemistry Lab



Physics Lab



Visit to Orphanage

## Vision

To be the most sought after academic, research and practice based department of Humanities and Applied Sciences that others would wish to emulate.

## Mission

Creating Exuberant Learners for Technical Education.

The Department of Humanities and Applied Sciences (HAS) deals with courses like Applied Physics, Chemistry, Mathematics and English and also coordinates with other Engineering departments for Engineering Mechanics, Basic Electrical and Electronics, Engineering Drawing, Environmental Sciences (EVS), Structured Programming Approach (SPA). The ebullient and lively HAS team nurture more than 322 students of first and second year from Engineering and Pharmacy programmes of AIKTC, by mentoring them, offering timely guidance and remedial teaching. Through mentoring mechanism, HAS keeps track on slow learners and provide them with additional coaching. The department also helps in improving communication skills of students and also newly joined staff/faculty members.



Prof. Arif Iqbal Shaikh (FE Controller)

(L-R): Row 1: Prof. Varsha Pawar, Prof. Rhuta Mahajan, Prof. Arif Iqbal Shaikh (FE Controller), Dr. Abdul Razak Honnutagi (Director), Prof. Maruf Quadari, Prof. Gazala Parveen. Row 2: Prof. Nargis Khan, Dr. Nussrat Junaidi, Prof. Ata-ul Mustafa Khan, Prof. Mudabbir Ansari, Prof. Rajee John, Prof. Shahid Anjum, Dr. Shahbaz Haque. Row 3: Mr. Salim Bagalkote, Mr. Dattatray Kamble, Mr. Suleman Shaikh, Dr. Sajid Iqbal, Prof. Mukhtar Shaikh, Mr. Kashif Dalvi.





# Bonhomie 2020 Fuerza

27 January- 04 February 2020

➤ The Council of Students (COST) of AIKTC organized Annual Sports, Cultural and Technical Fest, BONHOMIE 2020 Fuerza. All the dignitaries were received, escorted and given Guard of Honour by the Parade and Band team of AIKTC upon their arrival.

➤ Mr. Burhan Harris (Exe. Chairman, BINM, AI) presided the inaugural event on behalf of Dr. Zahir Kazi (President, AI) in the presence of Guest of Honour Dr. Jay Bhandarkar. A total of 12 technical events, 29 cultural events & 23 sports were organised where a record 5089 students participated.

➤ The winners were awarded in a wonderful valedictory ceremony in the presence of Mr. Burhan Harris and Chief Guest Mr. Fayaz Khan (Manager, Town Planning, CIDCO Ltd. Navi Mumbai). Dr. Abdul Razak Honnutagi (Director, AIKTC), Mr. Burhan Harris shared the recent achievements of AIKTC and encouraged the students to participate in such events to explore their hidden talent and showcase their creativity.

➤ More than 175 winners received trophies, medals, mementos and 2000 certificates for participants, coordinators and volunteers for their motivation. Students, faculty and staff members enjoyed and participated with full enthusiasm. Thus, the highly vibrant and exuberant, 9 day long gathering ended on a very positive note





## About the Programme:

A Pharmacist is an essential part of the pharmaceutical and health care industry and plays an important role not only in providing patients with the best possible healthcare but also health-care products. A Bachelor of Pharmacy Degree leads to registration as a 'Pharmacist' by The Pharmacy Council of India. The 8 semester (4 years) undergraduate programme equips a graduate with an ability to get on the fast track in one of the most dynamic industries in health care as Pharmaceutical Scientists with an extensive role: From Discovery to Delivery. The career puts you on the front line of patient care and offers opportunities for professional growth, exceptional financial rewards and the opportunity to help people.

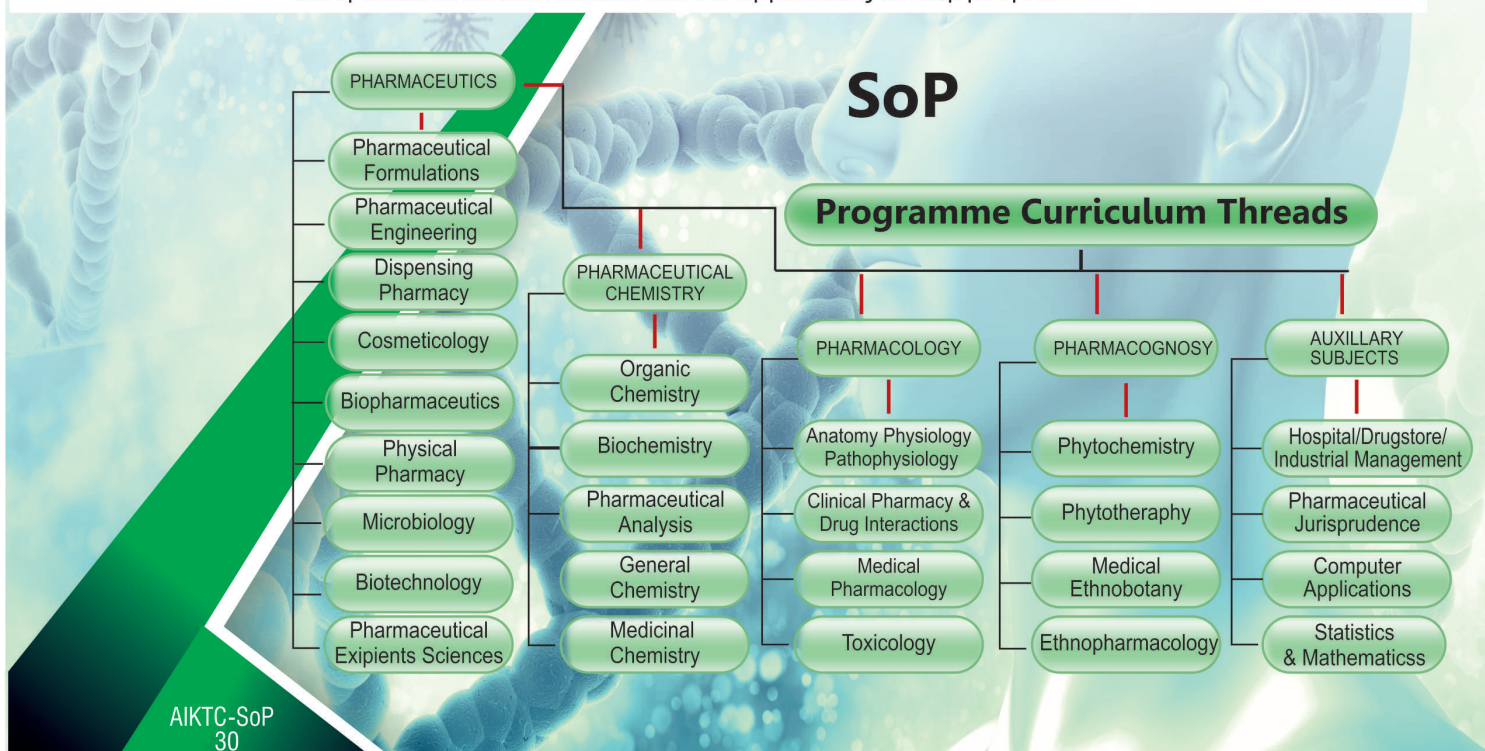



# Bachelor of PHARMACY

DTE Code : PH3439

Duration: 4 years

Intake: 100 seats

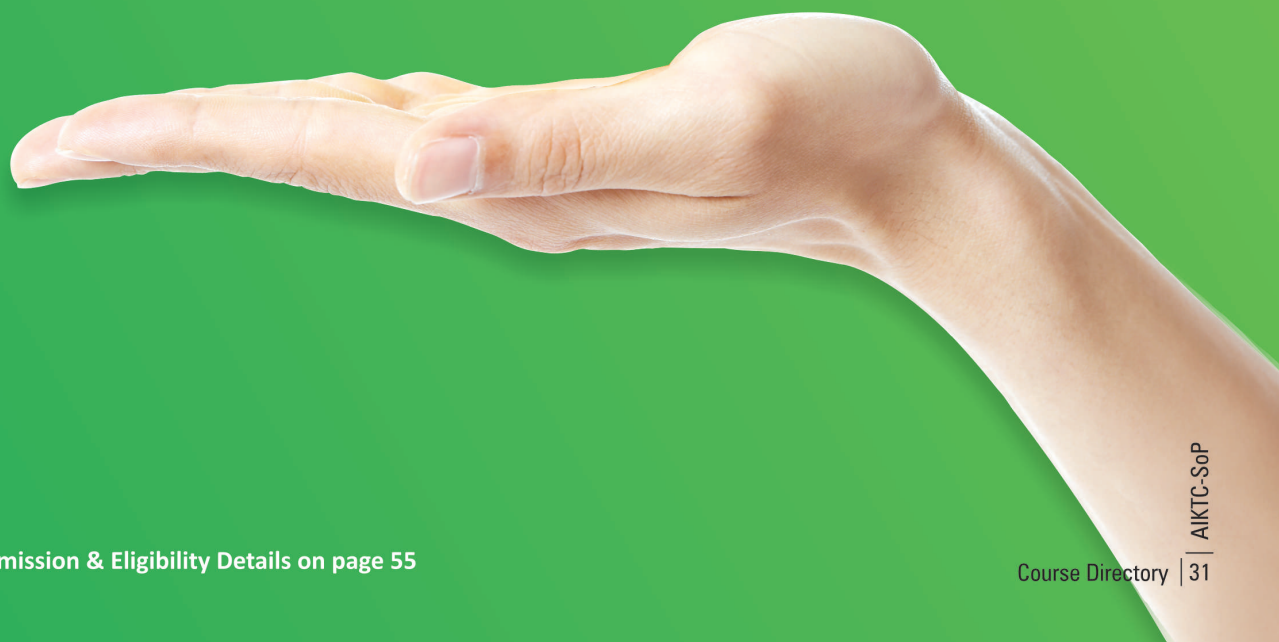

Admission & Eligibility Details on page 55

Course Directory | 31

AIKTC-SoP

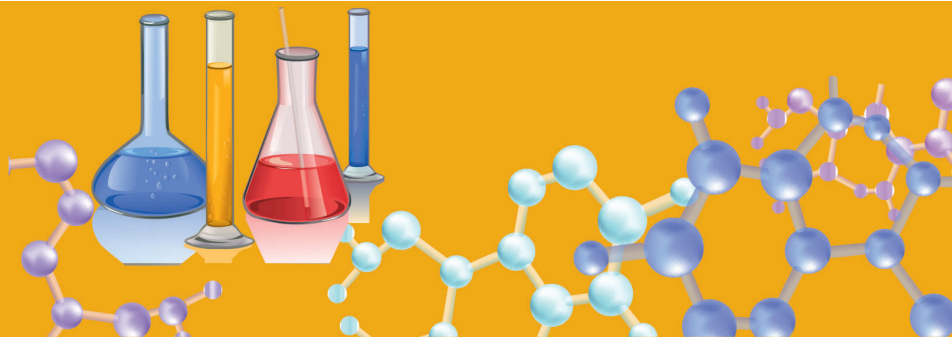

Cosmetology Lab

DTE Code  
PH3439



Pharmaceutical Chemistry Lab



Pharmacology Lab



Pharmacognosy Lab

### SoP Vision

To be the most sought after academic, research and practice based School of Pharmacy that others would wish to emulate.

### SoP Mission

Creating Exuberant Pharmaceutical Professionals.

### SoP Mission Elements

- To implement the Outcome Based Education (OBE) model to conform to our belief "Students Learn What We Teach".

---

- To encourage and upgrade teachers for innovative teaching skills, research and practice in Pharmacy.

---

- To provide necessary facility, machinery, equipment, atmosphere and ambience that would enable quality academics, research and practice in Pharmacy.

---

- To create an eco-system for professional competition and reward mechanism.

---

- To prepare and encourage students for direction and career of their choice. Be it higher studies, entrepreneurship, employment, research and innovations.

**SoP Programme Educational Objectives**

Build upon **comprehensive knowledge** of pharmaceutical sciences.

Be **significant contributory pharmaceutical professionals** in pharmaceutical and allied sectors.

Emerge/Act as **social responsible & ethically strong professionals**.

Be **emotionally intelligent contributory members** of society.



Best School (Cultural Events)  
Bonhomie 2020 Fuerza



Physical Pharmacy Lab



Pharma Analysis Lab



Pharmaceutics Lab



## AIKTC School of Pharmacy Events, Seminars & Workshops

1. One of the Best Anchor Award was won by Ms. Amina Hajwani at DLLE Fest UDAAN, University of Mumbai
2. First prize was won by Mr Yahya Shaikh at Ignition Competition 2020 at VES College of Pharmacy
3. Prizes bagged by Mr. Vedant Samant, Ms. Chandni and Mr. Saddam Idrisi at Rx Fest held for all colleges under University of Mumbai.
4. Mini workshop on Handling and Maintenance of Zebrafish Facility was conducted for external post graduate students.
5. Poster presentation by Ms. Amina Hajwani, Ms. Afreen Khan, Mr. Jeehan Chaudhary, Mr. Mohammed Ilyas in one day national seminar on encapsulating targeted drug delivery systems at MET College, Bandra.
6. Poster Presentation by Mr. Vedant Samant and Mr. Aadil Malik at Mega Industry-Institute Connect, KGRD College of Pharmacy, Karjat.
7. Paper presentation by 5 project team of Final Year students at IPCA 2020, Chennai.
8. Celebration of UDAAN Annual MU Fest at AIKTC by extension students.
9. Institutional Animal Ethical Committee (IAEC) Meeting and LIC meeting.
10. Pre-diabetic and Haemoglobin Health Camp, Student Solar Ambassador Workshop on 2nd October 2019 in collaboration with IIT, Bombay as a Part of Unnat Bharat Abhiyan activity of Ministry of Human Resource and Development.



11. Drug Awareness and Drug Interactions amongst cardiovascular drugs, Antitubercular drugs, drugs to be avoided during pregnancy, prevention and treatment of dengue on eve of world pharmacist day celebration.
12. Physiotherapy, Ophthalmology, Orthopaedic, Blood donation, Know your Health, Innovative booth competition and General Health Camp on eve of world pharmacist day celebration.
13. Sanitation and First Aid Awareness at Seawood Abyasika, Seva Sangh, NGO based school for underprivileged children by Extension students.
14. Industrial Visit at Influx Healthcare, Palghar for Second Year students.
15. One day workshop on Research Methodology for Final year students.
16. Nutrition education awareness in BMC School, Kurla, Environmental Awareness Camp at Panvel, Awareness on corona Disease at Central Park-Kharghar, Skin disease awareness camp for helpers, Stress Management workshop at AI School, Turbhe, Distribution of Hand Sanitizers prepared by Extension students to slums in Sion during Pandemi by Extension students.
17. Workshop on Ointment, Bottle filling & Bottle washing machine
18. Awareness on Safe and Effective Medicines at Orion Mall, Panvel.
19. Population Education Club Launch for social cause and awareness.



*During my 4 years study period I found my college to be the best hub of education. All faculty members were always ready for help. It gave me the opportunity to prosper not only in academics but also in sports and other cultural events. It was full of learning and grooming oneself. Overall it was a great experience and lifetime memory at AIKTC."*



**NAYAB MOHD ASADULLAH**  
First Rank (CGPI-8.33)



**TEAM : SCHOOL OF PHARMACY**

(L-R): **Row 1:** Ms. Aaqifa Patel, Dr. Ripu Daman, Prof. Samreen Khan, Dr. Shariq Syed (I/c Dean), Dr. Abdul Razak Honnutagi (Director), Prof. Abusufyan Shaikh, Prof. Priyanka Sanap. **Row 2:** Massarat Mukadam, Prof. Imran Shaikh, Prof. Ajaz Ahmed, Prof. Anwar Baig, Dr. Mohammed Shakeel Shamsi, Prof. Arulsevan Murugesan, Dr. Feroz Khan, Prof. Maria Lal. **Row 3:** Mr. Ramesh Dongre, Mr. Munnawar, Mr. Ubaid, Mr. Abhishek Pandey, Mr. Saba Rane.



### Career Paths

- ★ Formulation Industry
- ★ Teaching
- ★ Government and Institutional Pharmacy
- ★ Regulatory Affairs
- ★ Marketing & Sales
- ★ Many More ....
- ★ Transcription



### B.PHARM BATCH 2014-18



# AIKTC SCHOOL OF ARCHITECTURE

## About the Programme:

Architecture is the art and science of designing buildings and structures. It's a journey which requires Creativity, Passion, Confidence, Imagination, Good Communication, Drawing and Sketching skills. It includes within its scope the design of any built environment, structure or object, from Town Planning, Urban Design, Landscape Design to Furniture Design. The objective of the Course is to nurture Young Professionals who are sensitive designers with sound technical knowledge to address Society's concerns. This 5 year course is divided into Basic Course (1st to 3rd year) and Advanced Course (4th and 5th year). First three years is more of self exploration, interaction with small communities to understand their needs and Design for them. In the Advanced Course the focus is to understand larger communities and masses to be able to design at Urban/ City level. Finally one can say that Architecture is a very broad and humanistic field which demands you to be sensitive towards arts, aesthetics and possess sound knowledge in the fields of Engineering, Logistics and Ergonomics.



# Bachelor of ARCHITECTURE

DTE Code : AR3439

CoA Code: MH55

Duration: 5 years

Intake: 80 seats

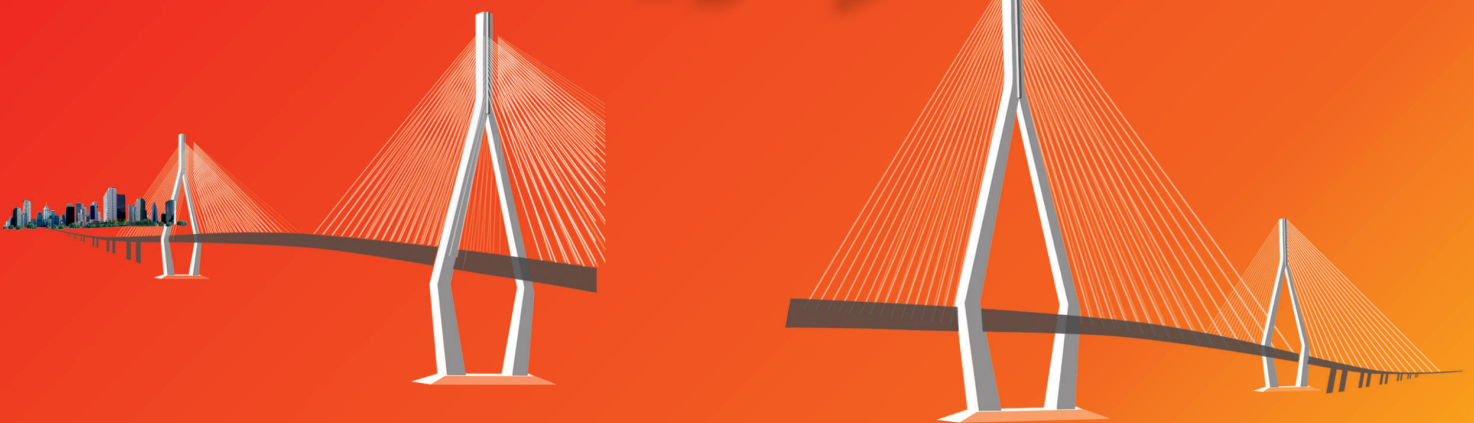

*Admission & Eligibility Details on page 54*

DTE Code  
**AR3439**

CoA Code : MH55

*I extend my sincere thanks to Almighty God, our parent's, faculties, supporting staff and friends for their support and guidance. AIKTC successfully creates a discipline and energetic ambience, by not only focussing on academics, but also extracurricular activities such as sports and cultural, thereby making us discipline, all-rounder, self-confident individuals and has led us to the entrance of a successful career.*



**SHAIKH SHIFA ISMAIL**  
First Rank (CGPI-8.11)

**SoA Vision**

To be the most sought after academic, research and practice based school of Architecture that others would wish to emulate.

**SoA Mission**

Creating Exuberant Architectural Professionals.



Bamboo Workshop



Post Tension Study Visit



Eco Brick Workshop



World Architecture Day Celebration with Ar. Ashlesha Kale and Ar. Suha Riyaz Khopatkar





### SoA Mission Elements

- To train professionals with competency to conceptualise, plan, design and detail, Built Environments and Spaces for human habitation, for all present and future uses and functions of the society.
- To foster an understanding of Private, Semi-public and public realms, to be able to recognize their differing needs and providing solutions within the socio-economic, legal and ethical framework.
- To train designers to meet the New Environmental challenges for sustainable lifestyles.
- To create a sound base in architectural technologies.
- To foster creativity and lateral thinking (between different fields of design) to be able to provide appropriate design solutions.
- To inculcate a sound base of architectural theory and history to create a comprehensive awareness about Architecture as a Discipline.
- To understand its relationships with other branches of knowledge such as liberal arts, sociology, economics and science.



Build your Success on a Strong Foundation





### AIKTC School of Architecture: Events, Seminars & Workshops

**KOLLOQUY:** An inspirational seminar series- discourse in sustainable practices. Three guest speakers Dr. Smita Khan, Ar. Yashita Shah and Ar. Dhruvang Hingmire have shared their experience in materials and unconventional techniques of design, green building project and environmental interaction followed by a panel discussion.

**KARYASHALA:** Hands on workshops on Mud Idol by Krupa Shah, Eco Brick Workshop by Tajuddin Ansari and Natural Plaster by Ar. Ashwin chari.

**Kamu Iyer Design Competition:** An yearly architectural competition held for third year students for all architecture colleges in Navi Mumbai.

**QALEEN Magazine release:** A yearly magazine published by AIKTC-School of Architecture.

Play performed by third year students on Secularism and Unity in Diversity during annual UDAAN Festival 2019-20 undertaken by DLLE, Department of University of Mumbai. It was hosted by AIKTC with 300 students across more than 20 colleges of Navi Mumbai.

Two days Bamboo Workshop was conducted for second year students in design studio.

A Timber Workshop was conducted for second year students to understand building elements in timber and its detailing.

Rammed Earth and Lime Plaster Workshop was conducted for second year students at Hunnarshala Foundation.

Two days Workshop was conducted on Architectural Sketching and Representation for first year students by Ar. Anshul D. Sinha.

Three days Metal Workshop was conducted for third year students to Construct Warren Truss Bridge Girder to 1:5 Scale.

Hands on Workshop conducted for second year students which deals with learning from traditional/vernacular design principles. Workshop was conducted in three different stages. In first stage, students made adobe (sun dried mud) bricks using local soil. In second stage, students constructed two walls using the same adobe bricks made in first stage. In third stage, students dealt with bamboo joineries, designed and executed a bamboo assembly over adobe brick walls. Objective of workshop was to make students exposed to design detailing while handling natural building material.

Small Marathon-Run jog walk activity conducted under SHIFA for creating awareness amongst students about fitness.



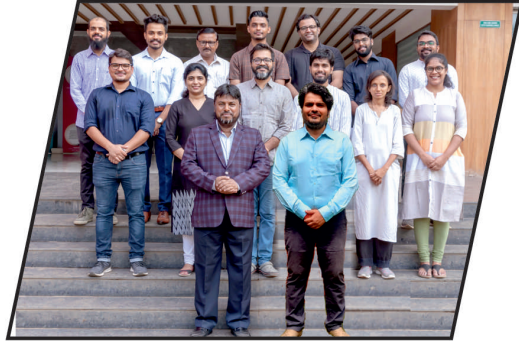

**TEAM : SCHOOL OF ARCHITECTURE**

**(L-R): Row 1:** Dr. Abdul Razak Honnutagi (Director), Mr. Raj Mahatre (I/c Dean).  
**Row 2:** Prof. Sandeepkumar Prajapati, Prof. Tanuja Mishra, Prof. Abhishek Kadam, Prof. Momin Zaki, Prof. Prajakta Wadwalkar, Prof. Shraddha Kadam. **Row 3:** Prof. Saddam Sayyed, Prof. Nikhil Balchandran, Mr. Laxman Jadhav, Prof. Zeeshan Kazi, Prof. Terence Yohannan, Prof. Fayazuddin Honnutagi, Prof. Parag Rawool.

# MASH-UP 2020



MASH-UP 2020 is a week long event at AIKTC's School of Architecture. It is a mixture of Creativity, Festivity and Learning. It is a combination of Skill, Talent, Technique, Games, Array, Food and Fun. Trimash, a part of the event, provided students with a platform to showcase their academics, art, sports, attire and food skills.



# CENTRAL LIBRARY: KNOWLEDGE RESOURCES & RELAY CENTRE (KRRC)

Institute  
DTE Code  
3439

## Library@Glance

Total Area	: 7,000 sq.ft.	National Journals	: 54
No. of Volumes	: 22,613	International Journals	: 6
No. of Titles	: 6,694	Magazines	: 25
Bound Journals	: 340	Project Reports	: 762
Audio-Visual Journals	: 803	Thesis/Dissertations	: 23
		Newspapers	: 14

## Vision

To be the most sought after Central Library, rich in academic and research based resources with ingenious practices that others would wish to emulate.

## Mission

Facilitating Exuberant Learning Knowledge Resources.

## eResources

**ASCE – Civil Engineering** : 35 eJournals with backfile access from 1983

**Videeya** : 102 eBooks of Indian Authors

**EBSCO Core Engineering** : 6038 eBooks

**Remote Access:** Access subscribed eResources anytime, anywhere

### **National Digital Library (NDL):**

★ 40 types of learning resources ★ 13 Lakhs+ items

★ 1 Lakhs+ Authors ★ 70 Languages

**E-PG Pathshala** : E-Content in 77 subjects at PG level.

**National Programme on Technology Enhanced Learning (NPTEL)** : Provides e-learning through online web and video courses in Engineering, Science, and Technology etc.

For more eResources explorer library website [www.aiktclibrary.org](http://www.aiktclibrary.org)

## ACHIEVEMENTS RANKING OF AIKTC REPOSITORY

★ AIKTC Repository is ranked 2648 in the World by CSIS-Cybermetrics Lab in April 2020.

★ Repository Indexed by Google | Google Scholar

### ★ Repository Registered in:

Directory of Open Access Repositories (OpenDOAR) hosted by University of Nottingham, UK.

Registry of Open Access Repository (ROAR) hosted by University of Southampton, UK.

Registry of Open Access Repository Mandates And Policies (ROARMAP) hosted by University of Southampton, UK.

Duraspace: Dspace User Registry

### Library Services

- Open Access System • Borrowing Facility • Online Reservation Facility • Internet Access Facility • Reading Room Facility
- Mobile QR Code • Whatsapp Group • Telegram Channel
- Current Awareness Service (CAS) • Selective Dissemination Service (SDI) • Reference Section
- Newspaper Clipping Service • New Arrival Service
- Reprographic/Scanning Facility
- Orientation Programme
- Extension Services etc...

Scan ME



to visit library website



### TEAM KRRC

(L-R): Row 1: Ms. Nazneen Palekar, Ms. Shaheen Momin (Librarian), Dr. Abdul Razak Honnutagi (Director), Ms. Usha Sharma. Row 2: Mr. Munnawar Sayyed, Mr. Afaq Syed, Mr. Rupesh Gaonkar, Mr. Saquib Adhikari, Mr. Zaid Bakshi.

### KEY FEATURES

**LIBRARY WEBSITE – JOOMLA (OSS)** : Stay updated with [www.aiktclibrary.org](http://www.aiktclibrary.org)

**LIBRARY AUTOMATION – KOHA (OSS)** : • Barcoding • Email & SMS Alert Service • Serial Control • Budget Analysis • CAS/SDI service etc ...

**WEBOPAC - [www.opac.aiktclibrary.org](http://www.opac.aiktclibrary.org):5000** : • Provides the facility of member login, searching and online reservation of materials available at library.. • Search books, subscribed journals, project reports, AV materials, eLearning Materials of Faculty's, Articles Abstract etc.

**INSTITUTIONAL REPOSITORY - DSpace (OSS)** : Accepts, archives and provides access to the scholarly and research works of AIKTC'ians, as well as works that reflect the intellectual environment of the campus.

**CD LIBRARY - DSpace (OSS)** : CDs/DVDs content uploaded on the Institutional Repository for easy access and future preservation.

**KAAD – KRRC Article Abstract Database** : • Search research article from subscribed print journals with KAAD platform. • More than 8000 articles indexed from different streams

**ANTI PLAGIARISM TOOL** : Avoid using CTRL+C and CTRL+V for your research work.

**LIBRARY BLOG** : Covers latest news in Architecture, Pharmacy and Engineering.

**WHAT's APP SERVICE (Faculty Only)**: Current news to respective school faculties.

**QUICK RESPONSE (QR) SERVICE** : QR Code is a barcode that contains data and read by a smart phone's camera. Service started to cater the needs of new generation students.



Book Exhibition



Reading Inspiration Day



User Orientation Program

# INNOVATIVE & EXUBERANT FACULTIES

## Teaching Staff

## Non-Teaching Staff

Name of Faculty	Designation	Qualification	Experience	Name of Staff	Designation	Qualification
-----------------	-------------	---------------	------------	---------------	-------------	---------------

**Dr. Abdul Razak Honnutagi**      **Director**      **Ph.D (IIT Bombay),FIE**      **33 yrs.**  
**M.E (Bldg Sc. & Tech.)(Hons)**  
**(IIT Roorkee), B.E. (Civil)**

### Civil Engineering

<b>Dr. Rajendra Magar</b>	<b>Prof.,HOD</b>	<b>M.E.(Civil),Ph.D(IIT Bombay)</b>	27 yrs.	Mr. Hasim Mulla	Jr. Clerk	(M.Com)*
	<b>IQAC Coordinator</b>	<b>FIE</b>		Mr. Masood Ali	Lab Asst.	(B.E. (Civil)*
Prof. Dhaval Shah	Asst. Prof.	M.Tech(Environment)(Ph.D)*	23 yrs.	Mr. Dadasaheb D.Randive	Lab Asst.	HSC (Sc), Civil
Prof. Dada Patil	Asst. Prof.	M.Tech (Structures),(Ph.D)*	17 yrs.			Draughtsman
Prof. Shafi Mujawar	Asst. Prof.	M.Tech (Structures)	20 yrs.	Mr. Patel Maqsud Ahmed	Lab Asst.	BCA
Prof. Parkar Fauwaz	Asst. Prof.	M.E.(Constr. Mgmt.),(Ph.D)*	11 yrs.	Mr. Shuja Ahmed	Lab Asst.	BE (Civil Engg);
Prof. Prabha Joshi	Asst. Prof.	Ph.D (Geology)	10 yrs.			PG Dip. in NICMAR
Prof. Junaid Maste	Asst. Prof.	M.E. (Structure),(Ph.D)*	09 yrs.	Mr. Sarfaraz Adhikari	Lab Attdt.	SSC
Prof. Hawelikar Shoukin	Asst. Prof.	M.E. (Structures)	12 yrs.	Mr. Abdul Majeed Patel	Lab Attdt.	HSC
Prof. Siddiqui Junaid	Asst. Prof.	M.E (Structures),(Ph.D)*	11 yrs.	Mr. Shams T. H. Shaikh	Lab Attdt.	HSC
Prof. Firoz Nadaf	Asst. Prof.	M.Tech (Structures)	08 yrs.	Mr. Rayees Pawle	Peon	SSC
Prof. Tehsin Kazi	Asst. Prof.	M.Tech (Trans.Engg.& Mgmt)	08 yrs.			
Prof. Umesh Jadhav	Asst. Prof.	M.Tech.(Constr. Mgmt.)	09 yrs.			
Prof. Prathamesh Gawade	Asst. Prof.	M.Tech.(Constr. Mgmt.)	13 yrs.			
Prof. Shivaji Sarvade	Asst. Prof.	M.Tech (Structures), (Ph.D)*	09 yrs.			
Dr.Girish Mahajan	Asst. Prof.	M.E.(Constr. Mgmt.) , Ph.D	20 yrs.			
Prof. Vedprakash C. Marlapalle	Asst. Prof.	M.E (Structure), (Ph.D)*	08 yrs.			
Prof. Wasim Shaikh	Asst. Prof.	M.Tech ( Structure),	06 yrs.			
Prof. Rohan Dasgupta	Asst. Prof.	M.E. (Structure),(Ph.D)*	10 yrs.			
Prof. Suhail Ahmad K. Ahmad	Asst. Prof.	(M.E.)*	04 yrs.			
Dr. Mehboobsab Nadaf	Asst. Prof.	Ph.D(IIT Bombay),M.E(Geotech)	06 yrs.			
Prof. Irfan Nalband	Asst. Prof.	M.E(Constr. Engg & Mgmt)	08 yrs.			
Prof. Sayyedzara Jahagirdar	Asst. Prof.	M.E( Structural Engg.)	05 yrs.			

### Computer Engineering

Prof. Khan Tabrez	l/c HOD	M.E. (Comp. Engg.)	17 yrs.	Mr. Sachin Savarde	Sys Enggr	MCA
Prof. Sheikh Javed Khan	Asst. Prof.	M.Tech (Computing & IT)	10 yrs.	Mr. Maviya Patel	Jr. Clerk	B.Com
Prof. Khan Mubashir	Asst. Prof.	M.E. (VLSI Design)	12 yrs.	Mr. Manohar L Dhawalkar	Lab Asst.	B.A.,CCNA,RHCE, MCSA,
Prof. Irfan Jamkhandikar	Asst. Prof.	(M.E.) (Comp. Engg.)*	08 yrs.			H/w Networking Engg.
Prof. Sayed Aamir Hashmi	Asst. Prof.	M.Tech (Comp. Engg.)	06 yrs.	Mr. Qazi Shahnawaz	Lab Asst.	Dip. Comp.Engg.,(AMIE)*
Prof. Abdus Salam	Asst. Prof.	M.Tech	07 yrs.	Mr. Khan Tufail Ahmed	Lab Asst.	CCNA, M.Sc (IT)
Prof. Kalpana Rohit Bodke	Asst. Prof.	M.E. (Comp. Engg.)	11 yrs.	Mr. Shaikh Vasimoddin	Lab Asst.	MCA
Prof. Rehaal Qureshi	Asst. Prof.	B.E. (Computer Engg)	05 yrs.	Mr. Md. Arif Quraishi	Lab Asst.	M.Sc. (IT)*
Prof. Apeksha M. Gopale	Asst. Prof.	M.E. (Computer Engg)	08 yrs.	Mr. Sandesh Mhatre	Peon	B.A.
Prof. Mukhtar Ansari	Asst. Prof.	M. Tech (CNIS)	10 yrs.	Mr. Shaikh Mohd. Nabeel	Peon	(B.A.)*
				Mr. Vishal Patil	Lab Attdt.	HSC
				Mr. Shahbaz Adhikari	Peon	XI

# INNOVATIVE & EXUBERANT FACULTIES

## Teaching Staff

## Non-Teaching Staff

Name of Faculty	Designation	Qualification	Experience	Name of Staff	Designation	Qualification
-----------------	-------------	---------------	------------	---------------	-------------	---------------

### Electrical Engineering

Prof. Syed Kaleem	l/c HOD	(M.E. )(Power Systems)*	24 yrs.	Mr. Majid Pathan	Jr. Clerk	B.Com
Prof. Patel Iftekar	Asst. Prof.	M.E. (Electronics)	12 yrs.	Mr. Survase Kiran	Instructor	HSC,ITI, ZTI
Prof. Ankur R. Upadhyay	Asst. Prof.	M.E. (Electronics)	11 yrs.	Mr. Broankar Hanif.A.G	Lab Asst.	Dip. In Electrical Engg.,(AMIE)*
Prof. Rizwan Farade	Asst. Prof.	M.Tech (Power Electronics), (Ph.D)*	11 yrs.	Mr. Irfan Daud Khot	Lab Asst.	Dip. In E.P.S.
Prof. Shraddha Hule	Asst. Prof.	M.E. (Power Elect. & Drives)	07 yrs.	Mr. Mohd. Tayyab P. Alam	Lab Asst.	Dip. Comp.Engg.
Prof. Tahoora Qureshi	Asst. Prof.	M.E.	05 yrs.	Mr. Mohd. Sharik Inamdar	Lab Asst.	Dip. Elect.Engg.
Prof. Yakub H. Khan	Asst. Prof.	M. Tech (Drives & Control)	23 yrs.	Mr. Shahvez Mulla	Lab Asst.	HSC,M.C.V.C.,(Dip. Electrical Engg.)*
Prof. Khan Mohsin A.	Asst. Prof.	M.E. (EXTC), (Ph.D)*	11 yrs.	Mr. Zubair Antulay	Lab Attdt.	SSC
Prof. Tanveer Hussain	Asst. Prof.	M.E (Power System)	07 yrs.	Mr. Shaikh Arshad Ali	Electrician	HSC,MCVC.,PWD
				Mr. Shaikh Dastagir	Peon	SSC

### Electronics & Telecommunication Engineering

Prof. Shaikh Afzal N. Ahmed	l/c HOD	M.E. (Electronics),(Ph.D)*	17 yrs.	Mr. Ansari Salman	Lab Asst.	Dip.EXTC Engg,(B.E)*
Dr. Tamboli Mujib Abbas	Asst. Prof.	Ph.D., M.E. (EXTC)	27 yrs.	Mr. Shaikh Imran A.Sattar	Lab Asst.	M.C.M.,Dip. H/N
Prof. Chaya S	Asst. Prof.	M.E. (EXTC), (Ph.D)*	12 yrs.	Mr. Muhammad Ismail	Lab Asst.	Dip.EXTC Engg,B.E
Prof. Awab Habib Fakih	Asst. Prof.	M.E. (EXTC), (Ph.D)*	09 yrs.	Mr. Mudassir M. Ameen	Lab	M. Sc
Prof. Bandanawaz Kotiyal	Asst. Prof.	M.Tech (Digital Comm.)	17 yrs.	Mr. Sameer Salunkhe	Instructor	
Prof. Pathan Siraj Rashid	Asst. Prof.	M.E. (EXTC), (Ph.D.)*	11 yrs.	Mr. Gulab Khatik	Peon	SSC
Prof. Khan Zarrarahmad	Asst. Prof.	M.E. (VLSI)	08 yrs.	Mr. Vikas Chavan	Peon	SSC
Prof. Rahul B. Khadase	Asst. Prof.	M.E. (Antenna & Wave Propagation), (Ph.D)*	09 yrs.	Mr. Zahid Mulla	Peon	HSC
Prof. Riyaz Pathan	Asst. Prof.	M.E. (EXTC), (Ph.D.)*	11 yrs.		Peon	HSC
Prof. Rizwan Alvi	Asst. Prof.	M.E. (Image Processing)	07 yrs.			
Prof. Mohammed Mazhar	Asst. Prof.	M.Tech (Digital Electronics & communication)	06 yrs.			
Prof. Altaf Balsing	Asst. Prof.	M.Tech (Embedded System)	08 yrs.			
Prof. Shahin Athavani	Asst. Prof.	CCNA Certified				
Prof. Geeta Desai	Asst. Prof.	M.E., (Ph.D)*	24 yrs.			
		M.E., (Ph.D)*	17 yrs.			

\*pursuing

Course Directory | 45

# INNOVATIVE & EXUBERANT FACULTIES

## Teaching Staff

## Non-Teaching Staff

Name of Faculty	Designation	Qualification	Experience	Name of Staff	Designation	Qualification
-----------------	-------------	---------------	------------	---------------	-------------	---------------

### Mechanical Engineering

Prof. Ansari Zakir Sajid	I/c HOD	M.Tech (Mech.)	13 yrs.	Mr. Waqas Dargawala	Jr. Clerk	(M.Com)*
Prof. Mohammad Jawed	Asst. Prof.	M.E. (Mfg. Sys Engg.)	19 yrs.	Mr. Khalil A Kalim Shah	Instructor	NCTVT, ITI
Dr. Md. Asif I. Gandhi	Asst. Prof.	M.E. (Production), (Ph.D)	22 yrs.	Mr. Shaikh Azeemuddin	Instructor	NCTVT, ITI
Prof. Ghazi Altamash Ahmed	Asst. Prof.	M.Tech (CAD/CAM)	09 yrs.	Mr. Abdul Kader Patel	Instructor	NCTVT, ITI,(Dip.)*
Prof. Atul Meshram	Asst. Prof.	M.E.(Manufacturing),(Ph.D)*	21 yrs.	Mr. Abdul N. A. Zameer	Instructor	Carpenter ITI
Prof. Nawaz Motiwala	Asst. Prof.	M.E. (Machine Design)	09 yrs.	Mr. Ab.Majid Rafiyuddin	Lab Asst.	Dip. Mech. Engg.
Prof. Momin Nafe	Asst. Prof.	M.E. (CAD/CAM +Robotics)	8.5 yrs.	Mr. Ansar G. Shaikh	Lab Asst.	Dip. Mech. Engg., NCTVT, ITI, (B. E.)*
Prof. Aslam Abbasali Hirani	Asst. Prof.	M.Tech (CAD/CAM)	10 yrs.	Mr. Dalvi Danish A.	Lab Asst.	Dip. Mech.Engg.,
Prof. Momin Mohd Z.M. Idris	Asst. Prof.	M.E. (CAD/CAM+Robotics)	17 yrs.	Mr. Khan Rehan A. R.	Lab Asst.	Dip. Comp. Engg.
Prof. Javed Kazi	Asst. Prof.	M.E. (CAD/CAM+Robotics)	08 yrs.	Mr. Pathan Salman Khan	Lab Asst.	Dip. Mech.Engg.,B.E.
Prof. Rahul Thavai	Asst. Prof.	M.E. (Machine Design)	08 yrs.	Mr. Asim Parkar	Lab Asst.	Dip. Mech.Engg.
Prof. Rizwan Mohd Sharif	Asst. Prof.	M.E. (Mfg. Sys Engg.)	11 yrs.	Mr. Mohd Mushtaq A.G.	Lab Attdt.	B.A.,Dip. Fire & Safety
Prof. Shaikh Saad Abdul Latif	Asst. Prof.	M.Tech. (Machine Design)	08 yrs.	Mr. Sayyed Faiz Ali	Lab Attdt.	Dip. Diesel Mech.,B.A.
Prof. Yusuf Khan	Asst. Prof.	M.Tech. (Machine Design),(Ph.D)*	09 yrs.	Mr. Zakir Shaikh	Lab Attdt.	HSC
Prof. Afaqahmed M. Jamadar	Asst. Prof.	M.E. (Mfg. Sys Engg.)	11 yrs.	Mr. Nadeem M Shafi	Peon	SSC
Prof. Shakil Babu Tadavi	Asst. Prof.	M.E. (CAD/CAM+Robotics)*	13 yrs.	Mr. Jamir Munde	Peon	HSC
Prof. Qureshi Arshad Khaja	Asst. Prof.	M.E. (Mfg. Sys Engg.)	08 yrs.	Mr. Fayaz Ahmed Khan	Peon	SSC, ITI, CNC
Prof. Shaha Ubaid	Asst. Prof.	M.Tech (Automobile Engg)	04 yrs.	Mr. Dilawar Khatik	Peon	SSC,
Prof. Jalal Ahemd Khan	Asst. Prof.	M.E. (Mfg. Sys Engg.)	08 yrs.			
Prof. Karve Amruta Rahul	Asst. Prof.	M. E. (Heat Power Engg)	06 yrs.			
Prof. Mohd.Sirazuddin Khan	Asst. Prof.	M. E. (CAD/CAM)	07 yrs.			

### Humanities and Applied Sciences

Prof. Shaikh Arif Iqbal	F.E. Controller	B.Ed., M.Sc. (Physics),(Ph.D)*	13 yrs.	Mr. M. Kashif Y. Dalvi	Jr. Clerk	M. Com
Prof. Ghazala Parveen	Asst. Prof.	B.Ed., M.Sc. (Chemistry)	16 yrs.	Mr. Dattatray N. Kamble	Lab Asst.	B.Sc. (Physics)
Prof. Rajee John	Asst. Prof.	B.Ed., M.Sc. (Maths)	25 yrs.	Mr. Shaikh Suleman	Lab Asst.	M.A. (English Literature), B.Sc. (Chemistry)
Prof. Varsha S Pawar	Asst. Prof.	M.Sc. (Chemistry);(Ph.D)*	19 yrs.	Mr. Salim M. Bagalkote	Lab Attdt.	HSC
Prof. Maruf Quadari	Asst. Prof.	M. A. (English Literature)	14 yrs.	Mr. Altaf Beg Musa Beg	Peon	SSC
Prof. Taib Quraishi	Asst. Prof.	M. A. (English Literature)	12 yrs.			
Prof. Shahid Anjum	Asst. Prof.	M.Sc.(Computational Maths)	10 yrs.			
Dr. Nusrath Junaidi	Asst. Prof.	M.Sc.,Ph.D. (Chemistry)	15 yrs.			
Prof. Khan Ata-ul-Mustafa	Asst. Prof.	M.Sc. (Maths)	11 yrs.			
Dr. Shahbaz A. Haque	Asst. Prof.	Ph.D,M.A. (English Literature)	08 yrs.			
Prof. Mukhtar Shaikh	Asst. Prof.	M.Sc. (Maths)	07 yrs.			
Prof. Nargis Kader Khan	Asst. Prof.	M. A. (English Literature)	06 yrs.			
Prof. Nitin Sonawane	Asst. Prof.	M.Sc (Physics)	16 yrs.			



# INNOVATIVE & EXUBERANT FACULTIES

## Teaching Staff

## Non-Teaching Staff

Name of Faculty	Designation	Qualification	Experience	Name of Staff	Designation	Qualification
<b>School of Architecture</b>						
Prof. Raj Mhatre	I/c Dean	M. Arch. (PM)	08 yrs.	Ms. Tanzeela Dalvi	Secretary	Dip. In IT
Prof. Poonam Mhatre	Professor	M. Arch (PM)	13 yrs.	Mr. Zoab Altaf Patel	Lab Asst.	B.Sc. (IT)
Prof. Mousami Wadikar	Professor	M. Arch(U.D.)	16 yrs.	Mr. Shoeb Khalifa	Lab Asst.	B.A.
Prof. Sandeepkumar Prajapati	Assoc. Prof.	M. Arch(U.D.)	13 yrs.	Mr. Amit Kharwar	Peon	HSC
Prof. Prajakta M. Wadwalkar	Assoc. Prof.	(M. Arch)*	11 yrs.	Mr. Jaywant Bhoir	Peon	SSC
Prof. Abhishek Kadam	Assoc. Prof.	M. Arch (PM)	10 yrs.	Mr. Laxman Jadhav	Lab Attd.	HSC
Prof. Parag Mohan Rawool	Assoc. Prof.	M. Arch (SA)	12 yrs.			
Prof. Shraddha Kadam	Assoc. Prof.	M.Arch (U.D)	12 yrs.			
Prof. Insha Shaikh	Asst. Prof.	M. Arch.	06 yrs.			
Prof. Siddhesh Kolambekar	Asst. Prof.	B. Arch.	06 yrs.			
Prof. Momin M. Zaki	Asst. Prof.	M. Arch	05 yrs.			
Prof. Suvidha Sagave	Asst. Prof.	M. Arch	6.5 yrs.			
Prof. Saddam Sayyed	Asst. Prof.	(M. Arch)*	04 yrs.			
Prof. Nikhil Balachandran	Asst. Prof.	B. Arch	04 yrs.			
Prof. Fayazuddin Honnutagi	Asst. Prof.	B. Arch	04 yrs.			
Prof. Murtuza Khandwala	Asst. Prof.	M.Arch (U & RP)	2.5 yrs.			
Prof. Terence Yohannan	Asst. Prof.	M.D.	2 yrs.			
Prof. Abhijit Nambiar	Asst. Prof.	M.Arch(U.D)	06 yrs.			
<b>School of Pharmacy</b>						
Dr. Shariq Syed	I/c Dean	M.Pharm,Ph.D. (USA)	12 yrs.	Mr. Asif Yusuf Amberkar	Lab Asst.	B.Sc.,DMLT
Prof. Abusufyan Shaikh	Asst. Prof.	M.Pharm, (Ph.D.)*	10 yrs.	Mrs. Khadija Shaibaz Kazi	Lab Asst.	B.Sc (Botany), Dip.GDCA
Prof. Ajaz A. S. Kutub Ali	Asst. Prof.	M.Pharm	12 yrs.	Mr. Vishwas Koli	Lab Asst.	B.Sc(Chemistry)
Prof. Mirza Anwar Baig	Asst. Prof.	M.Pharm, (Ph.D.)*	12 yrs.	Mr. Dalvi Wasif	Lab Asst.	B.Sc (Zoology)
Prof. Imran Sheikh	Asst. Prof.	M.Pharm, (Ph.D.)*	11 yrs.	Mrs. Rafiya Choudhary	Lab Asst.	B.Sc.
Dr. Nikhat Farhana	Asst. Prof.	M.Pharm, Ph.D.	11 yrs.	Ms. Aqifa Patel	Lab Asst.	M.Sc (EVS)
Prof. Saba Parveen Shaikh	Asst. Prof.	M.Pharm	07 yrs.	Mr. Hetavkar Imtiyaz	Lab Attd.	B.Com
Prof. Jayshree Patil	Asst. Prof.	M.Pharm, (Ph.D.)*	11 yrs.	Mr. Saba Rane	Lab Attd.	HSC
Prof. Lal Maria Ahmad	Asst. Prof.	M.Pharm	06 yrs.	Mr. Shakil Qazi	Lab Attd.	B.Sc., (DMLT)*
Prof. Arulselvan Murugesan	Asst. Prof.	M.Pharm, (Ph.D.)*	11 yrs.	Mr. Ramakant Pandey	Peon	HSC
Prof. Madhuri Gaikwad	Asst. Prof.	M.Pharm, (Ph.D.)*	12 yrs.	Mr. Abhishek Pandey	Peon	SSC
Prof. Mirza Salman Baig	Asst. Prof.	M.Pharm, (Ph.D.)*	07 yrs.	Mr. Imran Master	Peon	SSC
Dr. Feroz Khan	Asst. Prof.	M.Pharm, Ph.D.	03 yrs.	Mr. Ramesh Dongre	Peon	SSC
Prof. Samreen Khan	Asst. Prof.	M.Pharm	3.5 yrs.	Mr. Sunil Kharwar	Peon	HSC
Prof. Priyanka Sanap	Asst. Prof.	M.Pharm	05 yrs.	Mr. Munnawar Sayyed	Peon	HSC
Prof. Taufiq Mulla	Asst.Prof.	M.Pharm	07 yrs.	Mr. Ubaid Kazi	Lab. Asst.	B.Sc., (M.Sc)*
Prof. Mohd. Shakeel Shamsi	Visiting Doctor	B.A.M.S, M.D, Ph.D	17 yrs.	Mr. Aquib Salvi	Peon	HSC

\*pursuing

# TRAINING & PLACEMENT CELL



Campus Recruitment Training

Aptitude Training

Soft Skill Training

MoU with Blockology

The Placement Office is responsible for campus placement at AIKTC. The placement officer, the departmental Placement co-ordinators and the student representatives handle various crucial tasks in the office like reaching out to companies, scheduling & executing placement related activities and carrying out all official communication with recruiters and with students. The Training and Placement Cell not only carries out the placement activities of the students but organizes various development activities that help in personality grooming and also gives them platforms to express themselves and enhance their soft skills. The team TPO endeavors to strike a match between recruiter expectations and student aspirations. The Placement Office is well-equipped with excellent infrastructure to support every stage of the placement process.



Seminar on Cloud Computing  
Amazon Web Services

## Activities of the Placement Cell during Academic Year 2019-20:

- ☞ Soft Skills & Aptitude Training and other Personality Development Programmes through Curriculum.
- ☞ Seminars, Special Lectures, Career Guidance Programmes and Entrepreneurship Development Programmes.
- ☞ Placed in Domestic and Multinational Companies through ON/OFF Campus Recruitment.
- ☞ Motivated and Assisted Students in Industrial Training and Industrial Visits.



Career Building Seminar on a trigger toward  
IPSC, MPSC, IAS, IES foundation course

Seminar on Scope of Java Full Stack Development  
Artificial Intelligence & Machine Learning

Seminar on Higher Studies



Pre-placement talk on Opportunities in Indian Navy  
by Lt. Commander Pradeep Kothari, Indian Navy,  
Western Naval command



**TEAM : TRAINING & PLACEMENT CELL**

(L-R): Row 1: Prof. Javed Kazi (TPO), Abdul Razak Honnutagi (Director), Prof. Afaqhmed Jamadar ( Corporate Liaisoning Officer), Prof. Shahin Athavani.  
 Row 2: Prof. Altaf Baising, Prof. Arulselvan Murgesan, Prof. Vivek Tiwari, Prof. Dada Patil, Prof. Fayazuddin Honnutagi.



**A Small Glimpse of the Students placed in 2020**

 Faiyaz Khan Jaro Education Pvt.Ltd. 6.6 LPA	 Safiya Noor Shaikh Atos Syntel & Capgemini 3.8 LPA	 Altamas Shakeel Shaikh Capgemini & Infosys 3.8 LPA	 Nooras Fatima Ansari Atos Syntel & Infosys 3.8 LPA	 Mohammed Rehan Shaikh Capgemini 3.8 LPA	 Sahil Salauddin Sakharakar Neosoft & Infosys 3.6 LPA	 Mohammed Mobin Shaikh QualityKiosk 3 LPA	 Mohammed Shoaib Chandhary QualityKiosk 3 LPA
 Reema Salahuddin Harnekar Quality Kiosk 3 LPA	 Mohammed Rizwan Quality Kiosk 3 LPA	 Heena Mohd Rabis Khan QualityKiosk 3 LPA	 Shafaque Naushad Shaikh QualityKiosk 3 LPA	 Wasim Sayyed QualityKiosk 3 LPA	 Sudhakar Nadar Magicrot 3 LPA	 Ubaid Lore Magicrot 3 LPA	 Madni Mansuri Reliance Jio 2.5 LPA
 Kulna Khan Reliance Jio 2.5 LPA	 Aafria Mirza Reliance Jio 2.5 LPA	 Mayur Patil Reliance Jio 2.5 LPA	 Saransh Sharma Thyrocare 2.4 LPA	 Tajuddin Ansari AIDCO Infra Pvt. Ltd. Panvel 2.2 LPA	 Sabir Khan PreventiNe Life Care 2.16 LPA	 Satish Tiwari Tejus Construction Company Pune 2 LPA	 Adnan Shaikh SIMS

**Some of Our Top Recruiters**



## Fees & Refund of Fees

DTE Institute Code  
**3439**



### ANNUAL FEE STRUCTURE (as per clause mentioned by Fee Regulating Authority)

Name of School	First Year UG	Direct Second Year UG	PG	Ph.D
School of Engineering & Technology	Rs. 84,500/-	Rs. 80,500/-	Rs. 1,00,000/-	Rs. 1,00,000/-
School of Architecture	Rs. 1,45,500/*	---	----	----
School of Pharmacy	Rs. 95,500/-	Rs. 1,08,000/-	----	----

\* Conditional reduction applicable

### REFUND OF FEES

The Admission cancellation procedure will take place at Admission Reporting Centre before CAP Round 3 and after CAP Round 3 respective Institute will be responsible for cancellation process. The procedure is as follows:

- The Candidate shall apply online for cancellation through their login and submit signed copy of system generated application for cancellation of admission to the institution.
- After receiving admission cancellation request from the Candidate, the institution shall cancel the admission immediately and generate online acknowledgement of cancellation of admission through institution login and issue a signed copy to the Candidate.
- The refund of fees before cut-off date of admission shall be made within two days i.e. total fee minus the processing charges of Rs.1,000/-, or refund rule shall be as per the guidelines of the appropriate authorities or the State Government, as the case may be.
- If the admission is cancelled after the cut-off date of admission declared by the Competent Authority, there shall be no refund except the Security Deposit and Caution Money Deposit.

### Scholarships

**DTE Minority Scholarship (Rs.25000 per student):** <http://www.mahadbtmahait.gov.in>

**Economically Backward Class(EBC) Scholarship (50% Tuition Fees):** <http://www.mahadbtmahait.gov.in>

**Central Government Scholarship: Merit Cum Means Scholarship:** <http://www.scholarship.gov.in>

**Schemes available for Minority Students:** <http://www.minorityaffairs.gov.in>

**State Government Scholarship and Freeship for Reserved Category Students (50% of tuition fees for OBC students and 100% of tuition fees for SC/ST/NT Students):** <http://www.mahadbtmahait.gov.in>

## Rules & Regulations

### CONDITION OF MINIMUM ATTENDANCE:

The Students will not be allowed to appear for the examination if he/she does not attend minimum 75 percent classes of theory, practical, drawing etc.

### ACTION AGAINST RAGGING:

Maharashtra Prohibition of Ragging Act 1999 and Prevention and Prohibition of Ragging (Appendix 12 published in AICTE Approval Process Handbook (2011-12) and their amendments which may be published from time to time. The Maharashtra Prohibition of Ragging Act 1999 is in effect from 15th May, 1999 has the following provisions for Action against Ragging.

- a) Ragging within or outside of any educational institution is prohibited,
- b) Whosoever directly or indirectly commits, participates in, abets, or propagates ragging within or outside any educational institution shall, on conviction, be punished with imprisonment for a term up to 2 years and / or penalty, which may extend to ten thousand rupees.
- c) Any student convicted of an offence of ragging shall be dismissed from the educational institution and such student shall not be admitted in any other educational institution for a period of five years from the date of order of such dismissal.
- d) Whenever any student or, as the case may be, the parent or guardian or a teacher of an educational institution complains, in writing, of ragging to the head of the educational institution, the head of the educational institution shall, without prejudice to the foregoing provisions, within seven days of the receipt of the complaint, enquire into the matter mentioned in the complaint and if, prima facie, it is found true, suspend the student who is accused of the offence, and shall, immediately forward the complaint to the police station having jurisdiction over the area in which the educational institution is situated, for further action. Where, on enquiry by the head of the educational institution, it is found that there is no substance, prima facie, in the complaint received; he / she shall intimate the fact, in writing, to the complainant. The decision of the head of the educational institute shall be final.
- e) If the Head of the educational institution fails or neglects to act in the manner specified in section "d" above when a complaint of ragging is made, such person shall be deemed to have abetted the offence and shall, on conviction, be punished as provided for in section "b" above. Any Acts or its amendments which may be published from time to time by AICTE, Government or Judgments by Hon. Supreme Court of India, Hon. High Court of Bombay etc will be applicable to Candidates and Institutions covered under these rules of admission

#### Advertisement of Admission Notification in:

**Urdu Newspapers** : Inquilab, Urdu Times, Ratnagiri Times

**English Newspapers** : Hindustan Times / D.N.A. / Indian Express

**Marathi Newspapers**: Lokmat / Maharashtra Times / Loksatta / Ratnagiri Times

# Rules of Admission

DTE Institute Code  
**3439**

## Admission Process

For every admission at graduate level and post graduate level either the state CET/ any other CET as specified by the Government is mandatory. ● For Direct Second Year Degree Course in Engineering and Technology and Direct Second Year of Pharmacy course admissions CET is exempted. ● All admissions except for institutional quota shall be carried through the Centralised Admission Process which shall be monitored by the Competent Authority, The Commissioner. ● For all the Admissions the Candidatures type and its requirements are similar. ● CAP seats are filled through the CAP on the basis of inter se merit. The institutional seats are also filled on the basis of CET Merit. ● Changes in marks after verification are considered and the benefit of this revised score shall be given onwards from the point at which it is reported of. ● Backward class categories and Persons with Disability belonging to Maharashtra State only) in Appropriate branch

### Seat Distribution Chart

Seats Allocation for  
First Year Engineering

Seats Allocation for  
Direct Second Year  
Engineering

Name of Schools	DTE Choice Code	Type of Institution	Sanctioned Intake	No. of Seats as % of Sanctioned Intake					No. of Seats as 10 % of Sanctioned Intake	
				CAP Seats (80%)			Minority Quota (51%)	Institutional Quota (20%)		CAP Seats (100%) Minority Quota
				General Seats for Non-Minority Students (29%)		All India Seats 15% of General Seats for Non-Minority Students.				
				Maharashtra State (M.S) Candidate (85% of General Seats for Non-Minority Students)	70% of M.S for HU					
Unaided Minority Educational Institutions										
School of Engineering & Technology	343919110	Civil Engg.	120	21	9	5	61	24	12	
	343924510	Computer Engg.	60	10	4	3	31	12	06	
	343929310	Electrical Engg	60	10	4	3	31	12	06	
	343937210	Electronics & Telecomm. Engg.	60	10	4	3	31	12	06	
	343961210	Mechanical Engg	120	21	9	5	61	24	12	
School of Pharmacy	343982310	Pharmacy	100	17	8	4	51	20	10	
School of Architecture	343903210	Architecture	80	14	6	3	41	16	N.A.	
School of Engineering & Technology	343991010	PG in Construction Engineering & Management	18	3	1	0	10	4	N.A.	

www.aikt.ac.in

52 The above process will be liable to change as per the DTE, Maharashtra if any.

# School of Engineering & Technology

DTE Code  
EN3439

## Eligibility Criteria for admission to First Year Bachelor of Engineering (B.E.)

### Eligibility Criteria for Maharashtra State Candidature Candidates & All India Candidature Candidates, Union Territory of Jammu and Kashmir and Union Territory of Ladakh Migrant Candidature Candidates.

- (i) The Candidate should be an Indian National;
- (ii) Passed HSC or its equivalent examination with Physics and Mathematics as compulsory subjects along with one of the Chemistry or Biotechnology or Biology or Technical Vocational subject or Computer Science or Information Technology or Informatics Practices or Agriculture or Engineering Graphics or Business Studies and obtained atleast 45 % marks (at least 40 % marks, in case of Backward Class categories, Economically Weaker Section and Persons with Disability category candidates belonging to Maharashtra State), in the above subjects taken together;

#### AND

The Candidate should have appeared in all the subjects in CET and should obtain non zero score in CET conducted by the Competent Authority or should obtain non zero positive score in JEE (Main).

#### OR

- (ii) Passed Diploma in Engineering and Technology and obtained at least 45 % marks (at least 40 % marks, in case of Backward Class categories, Economically Weaker Section and Persons with Disability category candidates belonging to Maharashtra State);

### Eligibility Criteria for admission to Direct Second Year Bachelor of Engineering (B.E.)

### Eligibility Criteria for Maharashtra State Candidature Candidates & All India Candidature

- (i) The Candidate should be an Indian National;
- (ii) Passed Diploma Course in Engineering and Technology with at least 45% marks (40% marks in case of candidates of Backward Class categories, Economically Weaker Section and Persons with Disability category belonging to Maharashtra State) in appropriate branch of Engineering and Technology from an All India Council for Technical Education or Central or State Government approved Institution or its equivalent;

#### OR

- (ii) Passed B.Sc. Degree from a University Grants Commission (UGC) or Association of Indian Universities recognized University with at least 45% marks (40% in case of candidates of Backward Class categories, Economically Weaker Section and Persons with Disability category belonging to Maharashtra State) and passed HSC or its equivalent examination with Mathematics as a subject: Provided that students belonging to this category shall clear the subjects of Engineering Graphics or Engineering Drawing and

Engineering Mechanics of the first year Engineering Program along with second year subjects;

#### OR

- (ii) Passed D.Voc. Stream in the same or allied sector;
- (iii) In the above cases, a suitable bridge Courses, if required such as in Mathematics may be conducted;
- (iv) Any other criterion declared from time to time by the appropriate authority as defined under the Act.

### Eligibility Criteria for admission to Master of Engineering (M.E.) Eligibility Criteria for Maharashtra State Candidature Candidates & All India Candidature

- (i) The Candidate should be an Indian National;
- (ii) Passed Bachelor Degree in the relevant field of Engineering and Technology or Pharmacy from All India Council for Technical Education or Central or State Government approved institutions or equivalent, with at least 50% marks (at least 45% marks in case of candidates of Backward Class categories, Economically Weaker Section and Persons with Disability category belonging to Maharashtra State);
- (iii) Passed Bachelor Degree in the relevant course of Engineering and Technology or Pharmacy as specified in the eligibility criteria for admission to a Post Graduate Degree course of the concerned University for which admission is being sought;
- (iv) Obtained Qualified score in Graduates Aptitude Test in Engineering (GATE) conducted by the Indian Institute of Technology and valid for the current academic year;

#### OR

- (iv) Obtained non-Qualified marks in Graduates Aptitude Test in Engineering (GATE) conducted by the Indian Institute of Technology for the current academic year;

#### OR

- (iv) Obtained Qualified score in Graduates Pharmacy Aptitude Test (GPAT) conducted by National Testing Agency and valid for the current academic year;

#### OR

- (iv) Obtained non-Qualified marks in Graduates Pharmacy Aptitude Test (GPAT) conducted by National Testing Agency for the current academic year;

#### OR

- (iv) For sponsored candidates, minimum of two years of full time work experience in a registered firm/company/ industry/ educational and/ or research institute/ any Government Department or Government Autonomous Organization in the relevant field in which admission is being sought;
- (v) GATE or GPAT Qualified Candidates shall have preference over the not qualified Candidates.

**Please Note: Eligibility Criteria of Admission to all Courses may change as per DTE norms**

**Fee Structure:**

As decided by Fee Regulating Authority.

**Documents to be submitted****All Candidates**

1. MHT-CET/JEE-MAIN PAPER 1 Mark sheet
2. SSC (Std. X) Mark sheet and Passing Certificate
3. HSC (Std. XII) Mark sheet
4. HSC (Std XII) Leaving Certificate after passing HSC
5. HSC (Std XII) Passing Certificate(if available at the time of registration.
6. Domicile Certificate
7. Minority Declaration Affidavit
8. GAP Certificate (if applicable)

**Reserved Category Candidates :**

1. Caste certificate
2. Caste validity certificate
3. Non-creamy layer certificate  
(In addition to the documents mentioned for all candidates)

## School of Architecture



CoA Code : MH55

**Eligibility Criteria for admission to First Year Bachelor of Architecture (B.Arch.)****Eligibility Criteria for Maharashtra State Candidature Candidates & All India Candidature Candidates, Union Territory of Jammu and Kashmir and Union Territory of Ladakh Migrant Candidature Candidates.**

- (i) The Candidate should be an Indian National;
- (ii) Passed HSC or its equivalent with Physics, Chemistry and Mathematics or as declared by appropriate authority, from time to time

**OR**

- (ii) Passed (10+3) Full time Diploma examination recognized by All India Council for Technical Education or Central or State Government approved institution or its equivalent examination with Mathematics as compulsory subject or as declared by appropriate authority, from time to time;
- (iii) The Candidate should have obtained qualifying marks in NATA or JEE (Main) B.Arch;
- (iv) Any other criterion declared from time to time by the appropriate authority as defined under the Act: Provided that, provision mentioned in (ii) above shall be applicable only for the academic year 2020-21.

**Documents to be submitted**

1. NATA Score Card
2. SSC (Std X) Mark Sheet and Passing Certificate
3. HSC (Std XII) Mark Sheet
4. Leaving Certificate after passing HSC (Std. XII)
5. Domicile Certificate
6. Gap Certificate (if Applicable)
7. Minority Declaration Affidavit
8. Caste Certificate (if applicable)
9. Caste Validity Certificate (if applicable)
10. Non – Creamy Layer Certificate (If applicable)Valid

**Fee Structure:**

As decided by the Fee Regulating Authority

**Please Note: Eligibility Criteria of Admission to all Courses may change as per DTE norms**



# School of Pharmacy

DTE Code  
PH3439

## Eligibility Criteria for admission to First Year Bachelor of Pharmacy (B. Pharm.)

### Eligibility Criteria for Maharashtra State Candidature Candidates & All India Candidature Candidates

- (i) The candidate should be an Indian National;
- (ii) Passed HSC or its equivalent examination with Physics and Chemistry as compulsory subjects along with one of the Mathematics or Biology and obtained at least 45% marks (at least 40% marks in case of candidates of Backward Class categories, Economically Weaker Section and Persons with Disability category belonging to Maharashtra State) in the above subjects taken together;
- (iii) Should have appeared in all the subjects and should obtain non zero score in CET conducted by the Competent Authority.

#### OR

- (iii) Should obtain non zero positive score in NEET

## Eligibility Criteria for admission to Direct Second Year Bachelor of Pharmacy (B. Pharm.)

### Eligibility Criteria for Maharashtra State Candidature Candidates & All India Candidature

- (i) The Candidate should be an Indian National;
- (ii) Passed Diploma Course in Pharmacy with at least 45 % marks (at least 40 % marks in case of candidates of Backward Class categories, Economically Weaker Section and Persons with Disability category belonging to Maharashtra State) from an All India Council for Technical Education or Pharmacy Council of India or Central or State Government approved Institution or its equivalent.
- (iii) Any other criterion declared from time to time by the appropriate authority as defined under the Act.

## Documents to be submitted

### (1) Open Category Candidates

1. MHT-CET 2018 Score Card
2. SSC (Std X) Mark Sheet and Passing Certificate
3. HSC (Std XII) Mark Sheet
4. Leaving Certificate after passing HSC (Std. XII)
5. Domicile Certificate
6. HSC (Std XII) passing certificate (if available at the registration)
7. Minority Declaration Affidavit
8. Gap Certificate (if applicable)

### (2) Reserved Category Candidates

1. Caste Certificate
2. Caste Validity Certificate
3. Non-creamy layer certificate  
(In addition to the documents mentioned in Sr. No. 1)

## Fee Structure:

As decided by the Fee Regulating Authority



(L-R): Row 1: Prof. Tanuja Mishra, Prof. Maruf Qaidari, Dr. Abdul Razak Honnutagi (Director), Prof. Imran Sheikh, Prof. Rizwan Alvi. Row 2: Mr. Pramod Ghare, Mr. Mushahid Painter, Mr. Sameer Shaikh, Mr. Mahadev Shinde. Row 3: Mr. Affan Quraishi, Mr. Uwaish Master, Mr. Mukhtar Shaikh

**Please Note: Eligibility Criteria of Admission to all Courses may change as per DTE norms**

## NON-TEACHING STAFF

Name of Staff	Designation	Qualification
---------------	-------------	---------------

### Knowledge Resources & Relay Centre (Library)

Mrs. Shaheen Momin	Librarian	M.Phil (LIS), NET, SET
Mr. Sayed Afaq	Asst. Librarian	M.A., B.L.I.Sc
Mr. Zaid Bakshi	Asst. Librarian	B.Com, M.L.I.Sc. JCHNP
Mr. Rupesh Gaonkar	Library Asst.	BCA, B.L.I.Sc.
Ms. Usha Sharma	Library Asst.	B.A., M.L.I.Sc.
Ms. Nazneen Palekar	Library Asst.	B.Sc., DMLT, M.L.I.Sc.
Mr. Saquib Adhikari	Jr. Clerk	B. Com, B.L.I.Sc.
Mr. Zeeshan Dalvi	Peon	SSC
Mr. Irfan Dhepe	Library Attdt.	SSC
Mr. Ubeed Rasalkar	Peon	HSC

### Exam Cell

Mr. Mahadev Shinde	Sr. Clerk Exam	B.A.
Mr. Sameer Nazir Shaikh	Jr. Clerk	B.Com
Mr. Mushahid Ayyub Painter	Jr. Clerk	B.Com
Mr. Pramod Ghare	Jr. Clerk	(M.A.*)
Mr. Uwaish Yusuf Master	Jr. Clerk	B.Com
Mr. Mukhtar Mohd Shaikh	Peon	HSC, Comp. H/w & Networking
Mr. Imran Shaikh	Peon	SSC

### Stores Department

Mr. Dinesh Wani	Store keeper	D.Pharm
Mr. Humayun Sayyed	Store clerk	B.A.
Mr. Mohd. Aqueel Dalvi	Lab Attendant	HSC
Mr. Mohd. R. Imtiyaz Shaikh	Peon	(B.Com*)

### Maintenance Department

Mr. Abdus Salam	O. S. Maintenance	B.Com, MBA
Mr. Rizwan Rasalkar	AC Technician	HSC, Dip. in A.C.
Mr. Prakash Varangiri	AC Attendant	HSC
Mr. Muneer Khadim	Lab Attendant	HSC
Mr. Salman Khan	Maintenance Supervisor	(HSC*)
Mr. Atique Munde	Peon	SSC
Mr. Rafik Dalvi	Gardener	Std.V
Mr. Chandrakant Jamadade	Gardener	SSC
Mr. Zakir Dalvi	Gardener	SSC



**Administrative Team**

(L-R): Row 1: Mr. Abdus Samee Deshmukh, Dr. Jamil Daud, Dr. Abdul Razak Honnutagi (Director), Mr. Hussain Honnutagi, Mr. Abdus Salam. Row 2: Mr. Sayyad Humayun, Mr. Sohail Shaikh, Mr. Azam Mulla, Mr. Shahebaz Jamkhandi, Mr. Ganesh Gaikwad, Mrs. Ayesha Patel, Mrs. Nazima Dhepe, Mr. Dinesh Wani. Row 3: Mr. Rizwan Mulla, Mr. Arshad Shaikh, Mr. Majid Pittho, Mr. Mohd. Raees Shaikh, Mr. Saddam Nawdekar, Mr. Mohd. Aqueel Dalvi, Mr. Junaid Shaikh, Mr. Ateeq Munde, Mr. Shariff Shaikh, Mr. Khadeem.

Name of Staff	Designation	Qualification
---------------	-------------	---------------

### Administrative Department

Mr. Hussain Honnutagi	Office Superintendent	B.A., ITI
Mr. Abdus Samee Deshmukh	Accountant	B.Com., MBA, (M. Com*)
Ms. Parveenara Rehman	Director's P. S.	Dip. In Sec. Practice
Ms. Yogita T. Palve	Sr. Clerk	B.A.
Mr. Ganesh Gaikwad	Jr. Clerk	B.Com
Mr. Shaikh Sohail	Jr. Clerk	B.Com
Mr. Shahebaz Jamkhandi	Jr. Clerk	B.Com
Mr. Shoab Divde	Jr. Clerk	B.Com
Ms. Ayesha Patel	Jr. Clerk	B.Com
Mr. Junaid Hasham Shaikh	Jr. Clerk	M. Com
Mr. Azam Muzaffar Mulla	Jr. Clerk	M.Com
Mr. Jayesh Navgaonkar	Lab Attendant	B.Com
Ms. Nazima Dhepe	Lab Attendant	HSC
Mr. Saddam Nawdekar	Lab Attendant	HSC, ITI
Mr. Rizwanmulla	Naik	SSC, Auto. Tech.
Mr. Khan Shariff	Peon	SSC
Mr. Patel Afzal M.Hanif	Peon	HSC
Mr. Muazzam Patel	Peon	(HSC*)
Mr. Shafik Hamid Sayyed	Peon	SSC
Mr. Majid Pittho	Peon	SSC

# Committees

## COUNCIL OF STUDENTS @ AIKTC (2019-20)



### General Secretary

Noor-UI-Amin Mir (SoET-CE) :: Akbar Dudhniwala (SoA) :: Shagufta Shah (SoP)

### Cultural Secretary

Shahzer Khan (SoET-EE) :: Naushad Chaudhary (SoET-ME) :: Aroosa Shaikh (SoA) :: Ruksaar Kanekar (SoP)

### Sports Secretary

Shamshad Mallick (SoET-ET) :: Arshiya Shaikh (SoET-ET) :: Nabil Patel (SoA) :: Gufran Ali (SoP) :: Tuba Karbari (SoP)

### Technical Secretary

Saad Shaikh (SoET-ME) :: Farhan Khan (SoET-ME)

### Treasurer

Ariba Khalife (SoA)

## WOMEN DEVELOPMENT & GRIEVANCE CENTRE

(Erstwhile Internal Compliance Committee)

Sr.No:	Name Of Member	Designation
1.	DR. NUSRAT JUNAIDI	Controller (SoET)
2.	PROF. JAYASHRI PATIL	Coordinator (SoP)
3.	PROF. POONAM MHATRE	Coordinator (SoA)
4.	DR. ABDUL RAZAK HONNUTAGI	Member
5.	DR. RAJENDRA MAGAR	Teaching Staff Representative(CE)
6.	PROF. TABREZ KHAN	Teaching Staff Representative(CO)
7.	PROF. SYED KALEEM	Teaching Staff Representative(EE)
8.	PROF. ZAKIR ANSARI	Teaching Staff Representative(ME)
9.	PROF. ARIF IQBAL	Teaching Staff Representative(HAS)
10.	DR. SHARIQ SYED	Teaching Staff Representative(SoP)
11.	DR. JAMIL DAUD	Non Teaching Staff ReP. (Registrar)
12.	MRS. SHAHEEN ANSARI	Non Teaching Staff ReP. (KRCC)
13.	MRS. YOGITA PALVE	Non Teaching Staff Rep. (Admin)
14.	MS. AROOSA SHAIKH	Student Representative(SoA)
15.	MS. SHAGUFTA SHAH	Student Representative(SoP)
16.	MS. ARSHIYA SHAIKH	Student Representative(SoET)

## DISCIPLINE ANTI RAGGING SQUAD

Sr.No:	Name Of Member	School/Department
1.	PROF. ZAKIR ANSARI	Controller (SoET)
2.	PROF. SANDEEPKUMAR PRAJAPATI	Coordinator (SoA)
3.	PROF. MIRZA ANWAR BAIG	Coordinator (SoP)
4.	PROF. JUNAID SIDDIQUE	Member (SoET-CE)
5.	PROF. APEKSHA GOPALE	Member (SoET-CO)
6.	PROF. YAKUB KHAN	Member (SoET-EE)
7.	PROF. BANDANAWAZ KOTIYAL	Member (SoET-ET)
8.	PROF. GHAZALA PARVEEN	Member (SoET-HAS)
9.	PROF. ATAUL MUSTAFA KHAN	Member (SoET-HAS)
10.	PROF. ASLAM HIRANI	Member (SoET-ME)

**With You... Till You Do Not Need Us - In Any Way**

## **Some Institutes of Anjuman-I-Islam**

### **Secondary Schools (20)**

#### **Aided Secondary School**

A.I's Badruddin Tyabji Urdu High School, C.S.T.  
A.I's Ahmed Sailor High School  
A.I's J.M.C. High School of Commerce (Day)  
A.I's J.M.C. High School of Commerce (Night)  
A.I's Abdus Sattar Shuaib Secondary School  
A.I's M.H.S.S. Technical High School  
A.I's Saif Tyabji Girls High School  
A.I's Dr. M.I.J. Girls High School, Bandra  
A.I's Allana Boys Urdu High School, Kurla  
A.I's Allana Girls High School, Kurla (Urdu)  
A.I's Begum Jamila Haji Abdul Haq Urdu High School for Girls, Versova  
A.I's Mustafa Fakh High School (Vashi)  
A.I's Peermohamed High School (Pune)

#### **Un-Aided Secondary School**

A.I's Allana English High School C.S.T.  
A.I's Begum Sharifa Kalsekar English High School  
A.I's Allana English High School, Kurla  
A.I's High School (English Medium), Versova  
A.I's Abdul Azim Khatkhatay English Secondary School  
A.I's Ahmed Peermohd. English Secondary School, Pune

### **Primary Schools(15)**

#### **Aided Primary School**

A.I's Ahmed Sailor Girls Primary School  
A.I's Abdus Sattar Shuaib Primary School  
A.I's Saif Tyabji Girls Primary School  
A.I's K. Ziauddin Girls Primary School, Mahim  
A.I's Allana Urdu Primary School, Kurla  
A.I's Fazila Bai A. Sattar Oomer Primary School, Versova  
A.I's Zubeida Talib Primary School, Turbe  
A.I's VM & DM PM Urdu Primary School, Pune

#### **Un-Aided Primary School**

A.I's Allana English Primary School, C.S.T.  
A.I's Begum Sharifa Kalsekar Girls Primary English School  
A.I's Allana English Primary School, Kurla  
A.I's Primary School (English Medium), Versova  
A.I's A. A. Khatkhatay English Primary School, Vashi  
A.I's Ahmed Peermohd. English Medium Primary School, Pune  
A.I's Public School, Panchgani

### **Pre-Primary Schools(15)**

#### **Un-Aided Pre-Primary Schools**

A.I's Allana English Pre-Primary School, C.S.T.  
A.I's Akbar Peerbhoy English Nursery, C.S.T.  
A.I's Ahmed Sailor Pre-Primary School  
A.I's Abdus Sattar Shuaib Pre-Primary School  
A.I's Begum Sharifa Kalsekar Girls English Pre-Primary School  
A.I's Saif Tyabji Girls Pre-Primary School  
A.I's K. Ziauddin Girls Pre-Primary School, Mahim  
A.I's Allana Urdu Pre-Primary School, Kurla  
A.I's Allana English Pre-Primary School, Kurla  
A.I's Fazila Bai A. Sattar Oomer Pre-Primary School, Versova  
A.I's Pre-Primary School (English Medium), Versova  
A.I's Zubeida Talib Pre-Primary School, Turbhe  
A.I's A. A. Khatkhatay English Pre-Primary School, Vashi  
A.I's A. A. Khatkhatay English Pre-Primary School, Vashi  
A.I's Noor Nursery Urdu School, Pune

### **Junior Colleges(10)**

#### **Aided Junior Colleges**

A.I's Akbar Peerbhoy College of Commerce & Economics (Jr. College)  
A.I's M.H.S.S. Technical Jr. College  
A.I's Saif Tyabji Girls Jr. College  
A.I's Moinuddin Harris Jr. College of Education for Womens (D.Ed), Mahim  
A.I's Dr. M.I.J. Girls Jr. College, Bandra

#### **Un-Aided Junior Colleges**

A.I's Allana Jr. College of Science & Commerce, C.S.T.  
A.I's Begum Jamila Haji Abdul Haq College of Home Science, Versova  
A.I's Allana Jr. College of Commerce, Science & Arts (Kurla)  
A.I's Mustafa Fakh Jr. College of Commerce & Science (Vashi)  
A.I's Peermohamed Jr. College of Arts & Commerce (Pune)

### **Degree Colleges(12)**

#### **Aided Degree Colleges**

A.I's Akbar Peerbhoy College of Commerce & Economics (Degree College)  
A.I's Dr. M. I. J. Tibbia College & Hospital

#### **Un-Aided Degree Colleges**

A.I's College of Hotel & Tourism Mgt. Studies & Research (C.S.T.)  
A.I's Allana Institute of Mgt. Studies & A. K. Hafizka institute of Hotel Mgt. & Catering Technology  
A.I's M.H.S.S. College of Engineering  
A.I's Akbar Peerbhoy College of Education (Vashi) B.Ed.  
A.I's Allana Institute of Mgt. Studies  
A.I's Begum Jamila Haji Abdul Haq College of Home Science, Versova  
A.I's Kalsekar Technical Campus - School of Architecture, New Panvel  
A.I's Kalsekar Technical Campus - School of Pharmacy, New Panvel  
A.I's Kalsekar Technical Campus - School of Engineering & Technology, New Panvel  
A.I's College of Hospitality Mgt. Studies (Affiliated to Yashwantrao Chavan Maharashtra Open University Nasik) YCMOU

### **Polytechnics (4)**

#### **Aided Polytechnics**

A.I's M.H.S.S. Polytechnic

#### **Un-Aided Polytechnics**

A.I's Akbar Peerbhoy Girls Polytechnic  
A.I's Polytechnic for Girls Pune  
A.I's Abdul Razzak Kalsekar Polytechnic (Panvel)

### **Other Institutes (10)**

A.I's M.H.S.S. Industrial Training Institute (ITI)  
A.I's M.H.S.S. Polytechnic Extension Center, Solapur  
A.I's Homai Peerbhoy Computer Centre (C.S.T.)  
A.I's Computer Training Centre, C.S.T.  
A.I's M.H.S.S. Computer Center for Hardware & Networking  
A.I's A.E. Kalsekar Hospital  
A.I's Urdu Research Institute  
A.I's Adabi Printing Press  
A.I's Karimi Library

### **Hostels-2**

### **Sahara Units-2**

### **Orphanages-3**

### **Proposed Institutions-2**

Plot # 2 & 3, Sector-16, T :+91 (022) 2748 1247 / 48

Near Thana Naka, Khandagaon, F :+91 (022) 2748 1249

New Panvel, Navi Mumbai-410 206. E : aikt.newpanvel@aikt.ac.in

 [www.aikt.ac.in](http://www.aikt.ac.in)

 [aiktcofficial](#)

 [aiktcofficial](#)

 [aiktctv](#)

 [aiktcofficial](#)