

ULTRAFAST ACTING ELECTRONIC CIRCUIT BREAKER

*Report submitted
in
partial fulfillment of requirement
for the award of degree of*

**Bachelor of Engineering
in
Electrical Engineering**

Submitted by

ANSARI HUMAIS	17DEE39
KAZI YASIR	17DEE51
KHATRI FAIZ	17DEE53
SHAIKH MOHD WASI	17DEE67

Under The Guidance Of

PROF. ANKUR UPADHYAY



Department of Electrical Engineering

Anjuman-I-Islam's Kalsekar Technical Campus, Panvel

Mumbai University, Mumbai

2019-2020

CERTIFICATE

This is to certify that the project report entitled '**ULTRAFAST ACTING ELECTRONIC CIRCUIT BREAKER**' is a bonfire work done under my guidance by

- **ANSARI HUMAIS MOHD. ANWAR – 17DEE39**
- **KAZI YASIR ILYAS – 17DEE51**
- **KHATRI FAIZ WAJID – 17DEE53**
- **SHAIKH MOHD WASI MOHD SHAKIR – 17DEE67**

during the academic year 2019-20 in partial fulfillment of the requirements for the award of degree of Bachelor of Engineering in Electrical Engineering from University of Mumbai.

Place: Panvel

Date: / /2020

Prof. Ankur Upadhyay

Project Guide

Prof. Kaleem Sayyed

H.O.D

Dr. Abdul Razzak Honnutagi

Director

CERTIFICATE OF APPROVAL

The foregoing dissertation entitled ‘**ULTRAFAST ACTING ELECTRONIC CIRCUIT BREAKER**’ is hereby approved as a creditable study of Electrical Engineering presented by

- **ANSARI HUMAIS MOHD. ANWAR – 17DEE39**
- **KAZI YASIR ILYAS – 17DEE51**
- **KHATRI FAIZ WAJID – 17DEE53**
- **SHAIKH MOHD WASI MOHD SHAKIR – 17DEE67**

in a manner satisfactory to warrant its acceptance as a pre-requisite to their Degree in Bachelor of Electrical Engineering.

Internal Examiner

(Prof. Ankur Upadhyay)

External Examiner

DECLARATION

I declare that this written submission represents my ideas in my own words and where others ideas or words have been included; I have adequately cited and referenced the original sources. I also declared that I have adhered to all principles of academic honesty and integrity and have not represented or fabricated or falsified any idea/data/fact/source in my submission. I understand that any violation of the above will be cause for disciplinary action by the Institute and can also evoke penal action from the sources which have thus not been properly cited or from whom proper permission have not been taken when needed.

ANSARI HUMAIS

KAZI YASIR

KHATRI FAIZ

SHAIKH MOHD WASI

Date:

ACKNOWLEDGEMENT

It is indeed a matter of great pleasure and proud privilege to be able to present this project on **ULTRAFAST ACTING ELECTRONIC CIRCUIT BREAKER**. The completion of the project work which is partial fulfillment of Degree academic works is a milestone in student's life and its execution is inevitable in the hands of guide. I am highly indebted to the project guide Prof. Ankur Upadhyay for his invaluable guidance and appreciation for giving form and substance to this report. It is due to their enduring efforts, patience and enthusiasm which has given a sense of direction and purposefulness to this seminar report and ultimately made it success.

I would also like to express my deep regards and gratitude to my director, Dr. Abdul Razzak Honnutagi and Head of the Electrical Engineering Department (HOD) Prof. Sayed Kaleem for moral support and considerate attitude towards my short comings if any.

I would like to tender my sincere thanks to all faculties of Electrical Engineering Department and from other departments for their cooperation and valuable advice.

Last but not least I extend my sincere thanks to supporting staff and my friends who helped directly or indirectly to complete my academic work.

ABSTRACT

- The smart ultra fast electronic circuit breaker is designed to work as an over current protection device. Conventional circuit breakers like miniature circuit breaker or a fuse is good at breaking the circuit when a short circuit fault occurs. But when an overload fault occurs, the tripping time is slow and depends on the percentage of overload. However, for sensitive loads it is very important to activate the tripping mechanism at the shortest possible time, preferably instantaneously.

This project senses the current passing through a series element and the corresponding voltage drop is rectified to dc. This voltage is converted into a digital value and compared against a preset value by a microcontroller to generate an output that drives a relay to trip the load. The unit is extremely fast and overcomes the drawback of the conventional circuit breakers. It uses a PIC Microcontroller. The breaker will automatically reclose if it is a temporary fault and will alert the consumer via SMS if the fault is due to overloading. Furthermore, the breaker can be remotely closed by sending an SMS

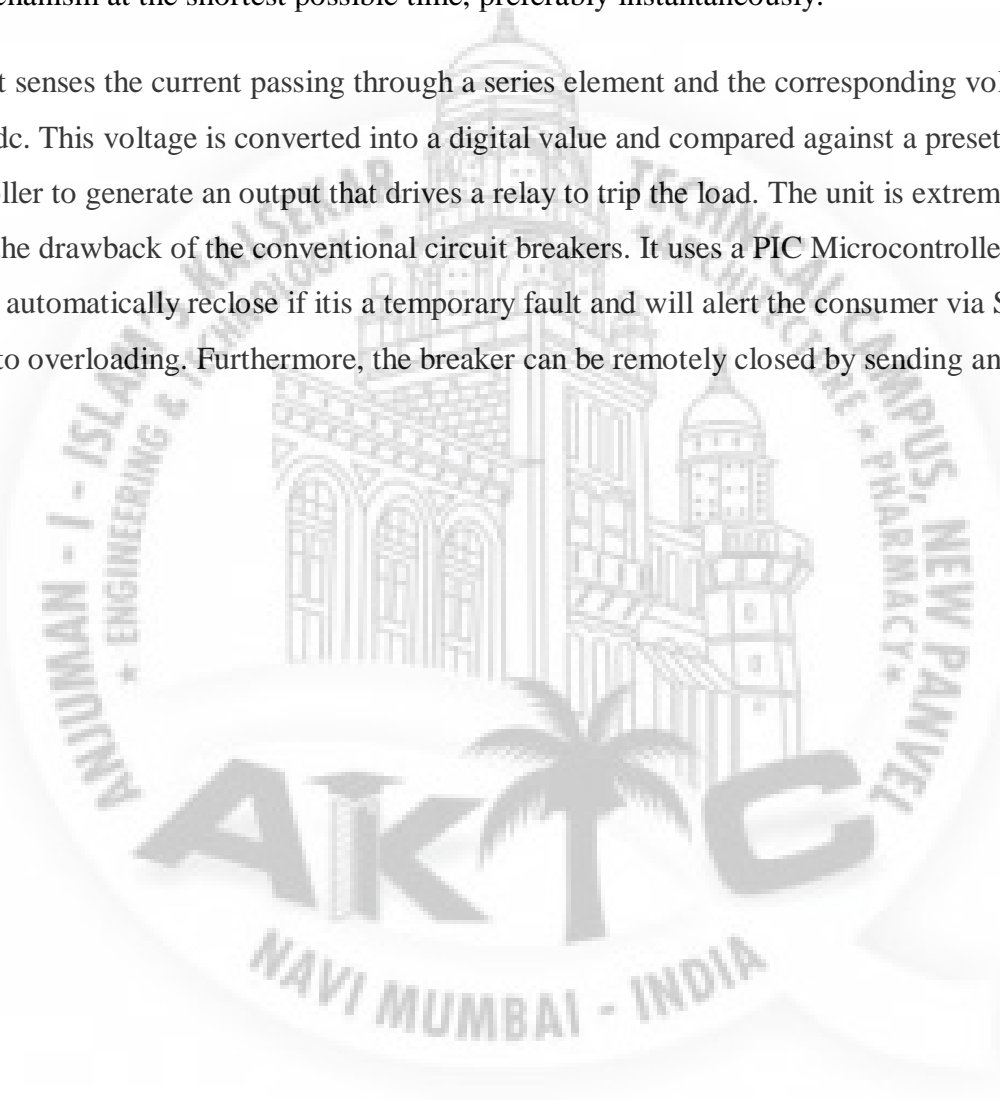

TABLE OF CONTENT

SECTION	DESCRIPTION	PAGE NO.
	ACKNOWLEDGMENT	
	ABSTRACT	
	LIST OF FIGURES	
	LIST OF TABLES	
CHAPTER 1	INTRODUCTION	01
1.1	INTRODUCTION OF PROJECT	01
1.2	LITERATURE REVIEW	02
CHAPTER 2	BLOCK DIAGRAM	03
2.1	BLOCK DIAGRAM OF CIRCUIT BREAKER	03
2.2	LCD DISPLAY	04
2.3	ATMEGA16	07
2.4	RELAY DRIVER	10
2.5	GAS SENSOR	14
2.6	POWER SUPPLY	16
CHAPTER 3	CIRCUIT DIAGRAM	20
3.1	CIRCUIT DIAGRAM OF RELAY	20
3.2	FUTURE OF CIRCUIT BREAKER	22
CHAPTER 4	COMPARISON	24
4.1	COMPARISON WITH OTHER BREAKERS	24
4.2	SMART CIRCIT PROTECTION	24
4.3	LIGHT SENSOR (LDR)	24
CHAPTER 5	HARDWARE TESTING	28
5.1	CONTINUITY TEST	28
5.2	POWER ON TEST	28
CHAPTER 6	RESULT	29
6.1	RESULTS	29
6.2	CONCLUSION	30
6.3	FUTURE SCOPE	30
CHAPTER 7	REFRENCES	31

LIST OF FIGURES

Figure no.	Title of Figure
1	BLOCK DIAGRAM
2	LCD DISPLAY MODULE
3	DIAGRAM OF ATMEGA
4	GAS SENSOR
5	BLOCK DIAGRAM OF REGULATED POWER SUPPLY
6	CIRCUIT DIAGRAM
7	INTERFACING OF LDR

LIST OF TABLES

Table No.	Title of Table
1	MAXIMUM RATING
2	TRIP CURRENT SETTING
3	BILL OF MATERIAL
4	WIRE SPECIFICATION

LIST OF ABBREVIATIONS

LDR	Light Dependent Resistor
BJT	Bipolar Junction Transistor
LED	Light Emitting Diode
NO	Normally Open
NC	Normally Close
IEEE	Institute of Electrical and Electronics Engineers

CHAPTER 1

INTRODUCTION

1.1 INTRODUCTION

Over-current protection devices are used to protect electrical systems from faults. The commonly used overcurrent protection devices are the fuse and the miniature circuit breaker.

The fuse is a small piece of wire which melts when a sufficiently large current passes through it. The miniature circuit breaker uses two mechanisms to protect systems against over-current. An electromagnetic plunger trips and breaks the current when a large current flows through the circuit, such as in the case of a short circuit fault. A bimetallic strip is used to break the circuit, when the current is small such as when an overload fault occurs. In this case, the bimetallic strip of the miniature circuit breaker begins to heat and the contacts separate eventually, thus breaking the circuit. The fuse and the miniature circuit breaker are perfect for protecting electrical circuits against short circuit faults. However, the fuse needs to be replaced after every fault. When an overload fault occurs, the tripping time is slow for the above mentioned systems as the tripping time is dependent on the percentage of overload.

Modern industries and appliances use very complex and sensitive electronic components. These systems are very sensitive and could easily burn out if over-current occurs. Thus modern day systems demand extremely fast tripping speed and high reliability as well as sensitivity. An electronic circuit breaker can meet these demands of the modern industry. The current passing through a circuit can be sensed and given to a microcontroller. The microcontroller will continuously check the value of this current against a preset current to ensure that the the current passing through the circuit is not above the rated value. If the current ever rises above the rated value, the microcontroller activates the tripping mechanism which will break the circuit. Since the microcontroller operates at 20 MHz, the operation is almost instantaneous.

The microcontroller can be programmed to operate as desired for different loads such as giving a time delay during the starting of a motor. The electronic circuit breaker can be reclosed either manually or remotely. A GSM module is integrated with the circuit breaker to allow the users to remotely close the breaker. Furthermore, it can be programmed to send messages to the users to alert them of fault conditions. The Smart Ultra fast acting electronic circuit breaker has numerous advantages compared to conventional over-current protection devices such as the fuse or miniature circuit breaker. Though it is more expensive, it makes up for it by its high operating speed and reliability.

1. 2 LITERATURE REVIEW

The history of power electronics is very much connected to the development of switching devices and it emerged as a separate discipline when high-power and MOSFET devices were introduced in the 1960s and 1970s. Since then, the introduction of new devices has been accompanied by dramatic improvement in power rating and switching performance. Because of their functional importance, drive complexity, fragility, and cost, the power electronic design engineer must be equipped with a thorough understanding of the device operation, limitation, drawbacks, and related reliability and efficiency issues. In the 1980s, the development of power semiconductor devices took an important turn when new process technology was developed that allowed integration of MOS and bipolar junction transistor (BJT) technologies on the same chip. Thus far, devices using this new technology have been introduced: insulated bipolar transition (IGBT) and MOS controlled thyristor (MCT). Many integrated circuit(IC) processing methods as well as equipment have been adapted for the development of power devices. However, unlike microelectronic ICs, which process information, power device ICs process power and so their packaging and processing techniques are quite different. Power semiconductor devices represent the heart of modern power electronics, with two major desirable characteristics of power semiconductor devices guiding their development:

1. Switching speed (turn-on and turn-off times)
2. Power handling capabilities (voltage blocking & current carrying capabilities)

Improvements in both semiconductor processing technology and manufacturing and packaging techniques have allowed power semiconductor development for high-voltage and high current ratings and fast turn-on and turn-off characteristics. Today switching devices are manufactured with amazing power handling capabilities and switching speeds as will be shown later. The availability of different

devices with different switching speeds, power handling capabilities, size, cost etc., makes it possible to cover many power electronics applications. As a result, trade-offs are made when it comes to selecting power devices.

CHAPTER 2

BLOCK DIAGRAM

2.1 BLOCK DIAGRAM

The main purpose of this paper is to develop a prototype of the Vehicle Black Box System VBBS that can be installed into any vehicle all over the world. This prototype can be designed with minimum number of circuits. The VBBS can contribute to constructing safer vehicles, improving the treatment of crash victims, helping insurance companies with their vehicle crash investigations, and enhancing road status in order to decrease the death

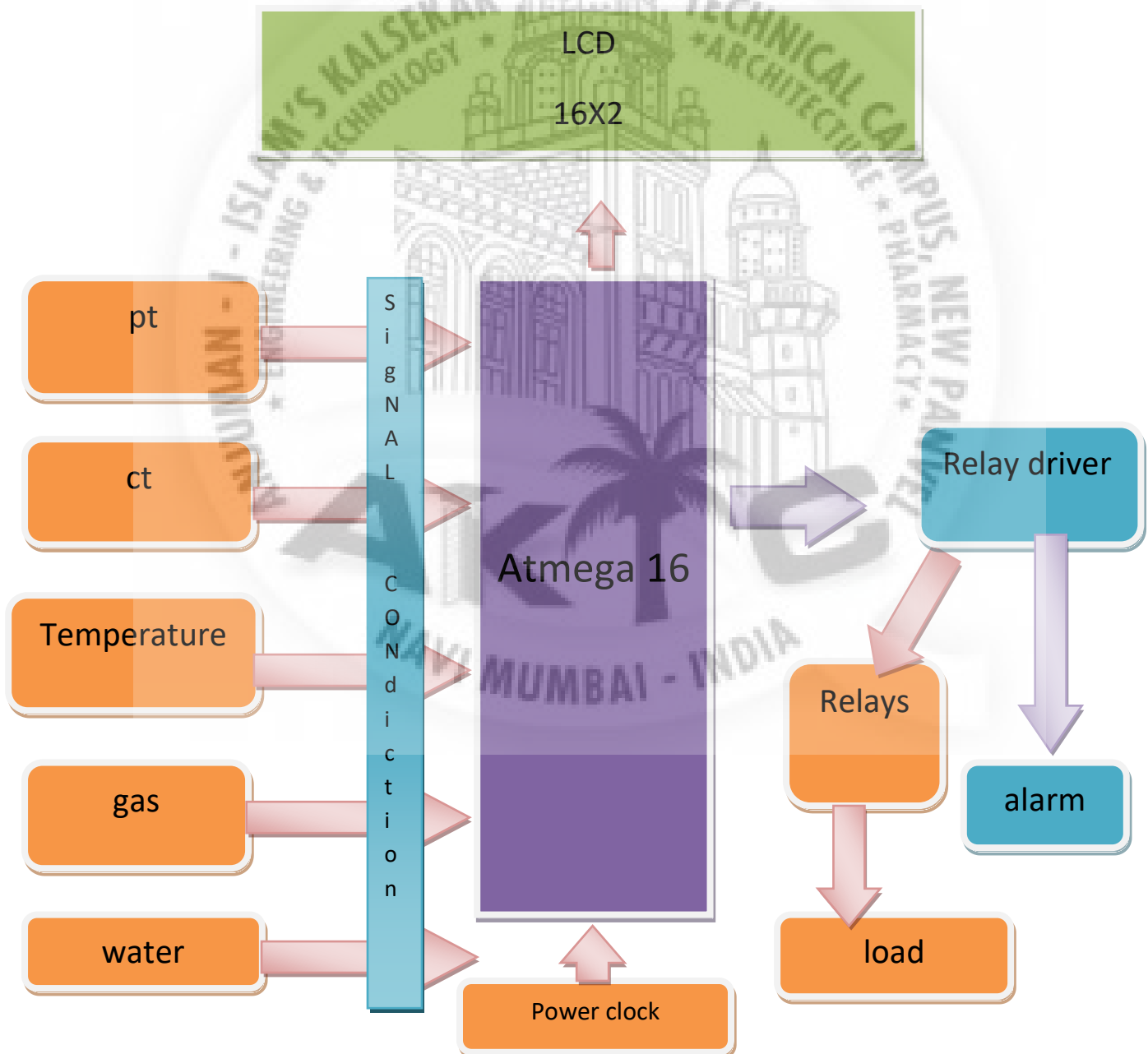

2.2 LCD DISPLAY

DISPLAY: Various display device such as seven segment display. LCD display, etc can be interfaced with microcontroller to read the output directly. In our project we use a two line LCD display with 16 characters each.

LCD: Liquid crystal Display (LCD) displays temperature of the measured element, which is calculated by the microcontroller. CMOS technology makes the device ideal for application in hand held, portable and other battery instruction with low power consumption.

GENERAL SPECIFICATION:

- Drive method: 1/16 duty cycle
- Display size: 16 character * 2 lines
- Character structure: 5*8 dots.
- Display data RAM: 80 characters (80*8 bits)
- Character generate ROM: 192 characters
- Character generate RAM: 8 characters (64*8 bits)
- Both display data and character generator RAMs can be read from MPU.
- Internal automatic reset circuit at power ON.
- Built in oscillator circuit.

Net Media 2x16 Serial LCD Display Module



PIN Configuration

JP1/JP14 Pins 1 – 8	Description	JP1/JP14 Pins 9 -16	Description
Pin1	Ground	Pin9	D2 (Not Used)
Pin2	VCC (+5)	Pin10	D3 (Not Used)
Pin3	Contrast	Pin11	D4
Pin4	Data/Command (R/S)	Pin12	D5
Pin5	Read/Write (W)	Pin13	D6
Pin6	Enable (E1)	Pin14	D7
Pin7	D0 (Not Used)	Pin15	VCC (LEDSV+)
Pin8	D1 (Not Used)	Pin16	Ground

LCD Control Codes

Description	Keyboard Code	ASCII or Decimal value
Display custom character 0-7	Ctrl-@ -Through- Ctrl-G	0 – 7
Backspace	Ctrl-H	8
Horizontal Tab	Ctrl-I	9
New Line	Ctrl-J	10

Vertical Tab	Ctrl-K	11
Form Feed (Clear Screen)	Ctrl-L	12
Carriage Return	Ctrl-M	13
Reset Controller	Ctrl-N	14
Set Geometry	Ctrl-O	15
Set Tab Size	Ctrl-P	16
Set Cursor Position	Ctrl-Q	17
*Not Used	*****	**
Set Contrast	Ctrl-S	19
Set Backlight	Ctrl-T	20
Command Escape	Ctrl-U	21
Data Escape	Ctrl-V	22
Raw Data Escape	Ctrl-W	23
*Not Used	*****	**
Display an ASCII Character	None	22 – 255

2.3 ATmega16

ATmega16 is an 8-bit high performance microcontroller of Atmel's Mega AVR family with low power consumption. ATmega16 is based on enhanced RISC (Reduced Instruction Set Computing, Know more about (RISC and CISC Architecture) architecture with 131 powerful instructions. Most of the instructions execute in one machine cycle. ATmega16 can work on a maximum frequency of 16MHz.

ATmega16 has 16 KB programmable flash memory, static RAM of 1 KB and EEPROM of 512 Bytes. The endurance cycle of flash memory and EEPROM is 10,000 and 100,000, respectively.

ATmega16 is a 40 pin microcontroller. There are 32 I/O (input/output) lines which are divided into four 8-bit ports designated as PORTA, PORTB, PORTC and PORTD.

ATmega16 has various in-built peripherals like USART, ADC, Analog Comparator, SPI, JTAG etc. Each I/O pin has an alternative task related to in-built peripherals. The following table shows the pin description of ATmega16.

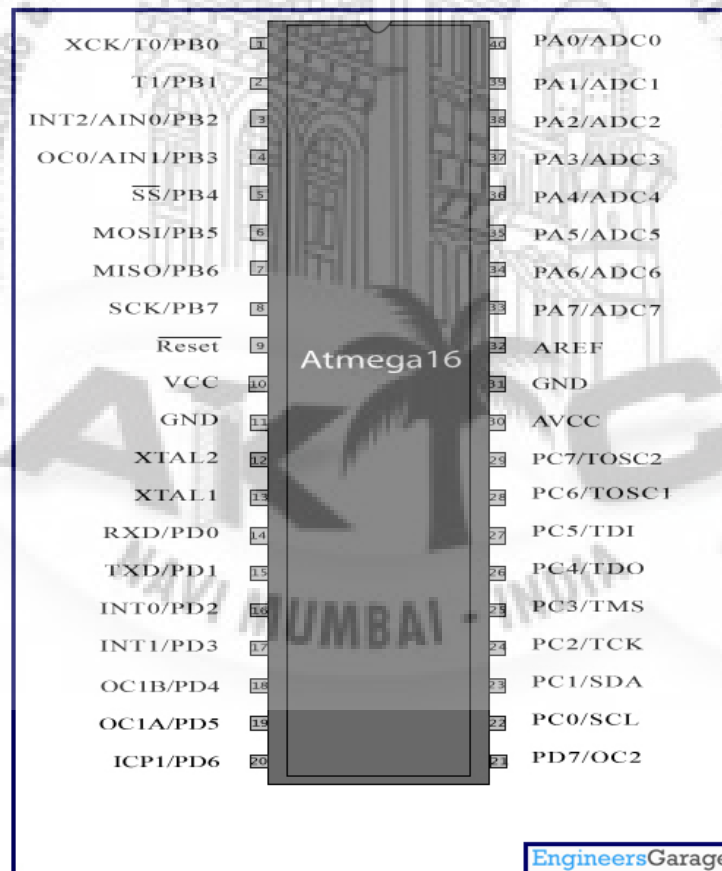

Fig ; Pin Diagram of Atme

Pin Description:

Pin No.	Pin name	Description	Alternate Function
1	(XCK/T0) PB0	I/O PORTB, Pin 0	T0: Timer0 External Counter Input. XCK : USART External Clock I/O
2	(T1) PB1	I/O PORTB, Pin 1	T1:Timer1 External Counter Input
3	(INT2/AIN0) PB2	I/O PORTB, Pin 2	AIN0: Analog Comparator Positive I/P INT2: External Interrupt 2 Input
4	(OC0/AIN1) PB3	I/O PORTB, Pin 3	AIN1: Analog Comparator Negative I/P OC0 : Timer0 Output Compare Match Output
5	(SS) PB4	I/O PORTB, Pin 4	In System Programmer (ISP) Serial Peripheral Interface (SPI)
6	(MOSI) PB5	I/O PORTB, Pin 5	
7	(MISO) PB6	I/O PORTB, Pin 6	
8	(SCK) PB7	I/O PORTB, Pin 7	
9	RESET	Reset Pin, Active Low Reset	
10	Vcc	Vcc = +5V	
11	GND	GROUND	
12	XTAL2	Output to Inverting Oscillator Amplifier	
13	XTAL1	Input to Inverting Oscillator Amplifier	
14	(RXD) PD0	I/O PORTD, Pin 0	USART Serial Communication Interface
15	(TXD) PD1	I/O PORTD, Pin 1	
16	(INT0) PD2	I/O PORTD, Pin 2	External Interrupt INT0
17	(INT1) PD3	I/O PORTD, Pin 3	External Interrupt INT1
18	(OC1B) PD4	I/O PORTD, Pin 4	PWM Channel Outputs
19	(OC1A) PD5	I/O PORTD, Pin 5	
20	(ICP) PD6	I/O PORTD, Pin 6	Timer/Counter1 Input Capture Pin
21	PD7 (OC2)	I/O PORTD, Pin 7	Timer/Counter2 Output Compare Match Output

22	PC0 (SCL)	I/O PORTC, Pin 0	TWI Interface
23	PC1 (SDA)	I/O PORTC, Pin 1	
24	PC2 (TCK)	I/O PORTC, Pin 2	JTAG Interface
25	PC3 (TMS)	I/O PORTC, Pin 3	
26	PC4 (TDO)	I/O PORTC, Pin 4	
27	PC5 (TDI)	I/O PORTC, Pin 5	
28	PC6 (TOSC1)	I/O PORTC, Pin 6	Timer Oscillator Pin 1
29	PC7 (TOSC2)	I/O PORTC, Pin 7	Timer Oscillator Pin 2
30	AVcc	Voltage Supply = Vcc for ADC	
31	GND	GROUND	
32	AREF	Analog Reference Pin for ADC	
33	PA7 (ADC7)	I/O PORTA, Pin 7	ADC Channel 7
34	PA6 (ADC6)	I/O PORTA, Pin 6	ADC Channel 6
35	PA5 (ADC5)	I/O PORTA, Pin 5	ADC Channel 5
36	PA4 (ADC4)	I/O PORTA, Pin 4	ADC Channel 4
37	PA3 (ADC3)	I/O PORTA, Pin 3	ADC Channel 3
38	PA2 (ADC2)	I/O PORTA, Pin 2	ADC Channel 2
39	PA1 (ADC1)	I/O PORTA, Pin 1	ADC Channel 1
40	PA0 (ADC0)	I/O PORTA, Pin 0	ADC Channel 0

2.4 RELAY DRIVER

ULN2803

The eight NPN Darlington connected transistors in this family of arrays are ideally suited for interfacing between low logic level digital circuitry (such as TTL, CMOS or PMOS/NMOS) and the higher current/voltage requirements of lamps, relays, printer hammers or other similar loads for a broad range of computer, industrial, and consumer applications. All devices feature open-collector outputs and free wheeling clamp diodes for transient suppression.

The ULN2803 is designed to be compatible with standard TTL families while the ULN2804 is optimized for 6 to 15 volt high level CMOS or PMOS.

Features

1. Eight darling tons with common emitters;
2. Output current to 500 Ma;
3. Output voltage to 50 V;
4. Integral suppression diodes;
5. Versions for all popular logic families;
6. Output can be paralleled;
7. Inputs pinned opposite outputs to simplify board layout.

PIN CONNECTION (top view)

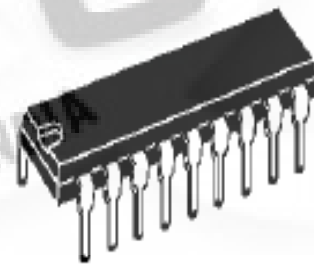
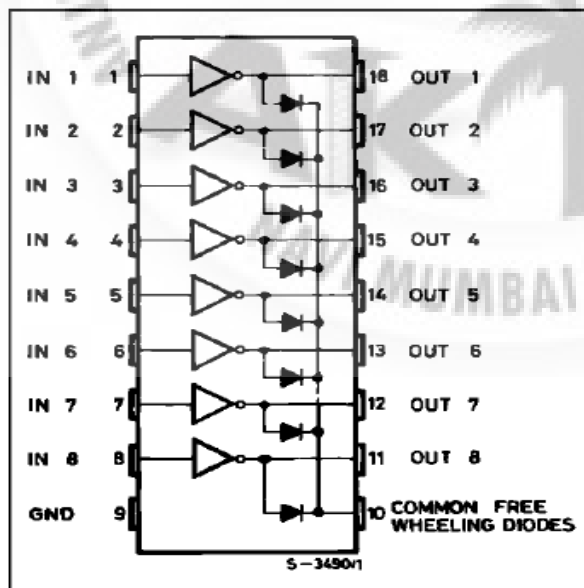

DIP18

Description

The ULN2801A-ULN2805A each contains eight Darlington transistors with common emitters and integral suppression diodes for inductive loads. Each Darlington features a peak load current rating of 600mA (500mA continuous) and can withstand at least 50V in the off state. Outputs maybe paralleled for higher current capability.

Five versions are available to simplify interfacing to standard logic families: the ULN2801A is designed for general purpose applications with a current limit resistor; the ULN2802A has a 10.5k input resistor and zener for 14-25V PMOS; the ULN2803A has a 2.7k input resistor for 5V TTL and CMOS; the ULN2804A has a 10.5k input resistor for 6-15V CMOS and the ULN2805A is designed to sink a minimum of 350mA for standard and Schottky TTL where higher output current is required. All types are supplied in an 18-lead plastic DIP with a copper lead from and feature the convenient input opposite-output pinout to simplify board layout.

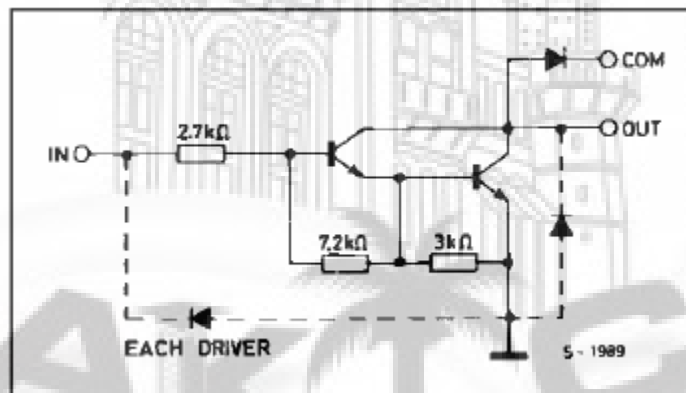

Temperature

Thermistor: NTC thermistor, bead type, insulated wires

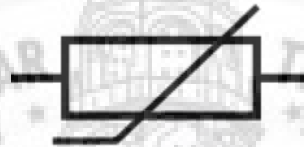

Thermistor symbol

A **thermistor** is a type of resistor with resistance varying according to its temperature. The word is a portmanteau of *thermal* and *resistor*. Samuel Ruben invented the thermistor in 1930, and was awarded U.S. Patent No. 2,021,491.

Thermistors are widely used as inrush current limiters, temperature sensors, self-resetting overcurrent protectors, and self-regulating heating elements.

Assuming, as a first-order approximation, that the relationship between resistance and temperature is linear, then:

$$\Delta R = k\Delta T$$

where

ΔR = change in resistance

ΔT = change in temperature

k = first-order temperature coefficient of resistance

Thermistors can be classified into two types depending on the sign of k . If k is positive, the resistance increases with increasing temperature, and the device is called a positive temperature coefficient (PTC) thermistor, or **posistor**. If k is negative, the resistance decreases with increasing temperature, and the device is called a negative temperature coefficient (NTC) thermistor. Resistors that are not thermistors are designed to have a k as close to zero as possible, so that their resistance remains nearly constant over a wide temperature range.

Thermistors differ from resistance temperature detectors in that the material used in a thermistor is generally a ceramic or polymer, while RTDs use pure metals. The temperature response is also different; RTDs are useful over larger temperature ranges.

Applications

- PTC thermistors can be used as current-limiting devices for circuit protection, as replacements for fuses. Current through the device causes a small amount of resistive heating. If the current is large enough to generate more heat than the device can lose to its surroundings, the device heats up, causing its resistance to increase, and therefore causing even more heating. This creates a self-reinforcing effect that drives the resistance upwards, reducing the current and voltage available to the device.
- PTC thermistors can be used as heating elements in small temperature-controlled ovens. As the temperature rises, resistance increases, decreasing the current and the heating. The result is a steady state. A typical application is a crystal oven controlling the temperature of the crystal of a high-precision crystal oscillator. Crystal ovens are usually set at the upper limit of the equipment's temperature specification, so they can maintain the temperature by heating.
- NTC thermistors are used as resistance thermometers in low-temperature measurements of the order of 10 K.
- NTC thermistors can be used as inrush-current limiting devices in power supply circuits. They present a higher resistance initially which prevents large currents from flowing at turn-on, and then heat up and become much lower resistance to allow higher current flow during normal operation. These thermistors are usually much larger than measuring type thermistors, and are purposely designed for this application.

- NTC thermistors are regularly used in automotive applications. For example they monitor things like coolant temperature and/or oil temperature inside the engine and provide data to the ECU and indirectly the dashboard.
- Thermistors are also commonly used in modern digital thermostats and to monitor the temperature of battery packs while charging.

2.5 GAS SENSOR

A GAS sensor or a GAS Detector is a type of chemical sensor which detects/measures the concentration of gas in its vicinity. Gas sensor interacts with a gas to measure its concentration. They are used in various industries ranging from medicine to aerospace. Various technologies are used to measure Gas concentration such as semiconductors, oxidation, catalytic, infrared, etc. The most common types are as follows

1. Metal Oxide Based GAS Sensor.
2. Capacitance Based GAS Sensor.
3. Acoustic Based GAS Sensor.
4. Calorimetric GAS Sensor.
5. Optical GAS Sensor.
6. Electrochemical GAS Sensor.

Over here we will focus on the most commonly available GAS sensor which is Metal Oxide Gas Sensor or Metal Oxide Semiconductor (MOS) also called as "**Chemiresistors**". The detection is based upon change of resistance of the sensing material when the Gas comes in contact with the material. These Metal Oxide Gas Sensor are extensively used in industry because of their low cost, flexibility in production; simplicity of their use; large number of detectable gases/possible application fields.

Various gas sensors are available in the market but the most commonly available series is the "**MQ Series**". Various gasses like, LPG, Carbon Monoxide (CO), Methane, Smoke, Alcohol, etc can be monitored using these sensors. A good thing about these series is that all are 6 pin sensors with same footprint, same interfacing circuit and are easily available at low cost.

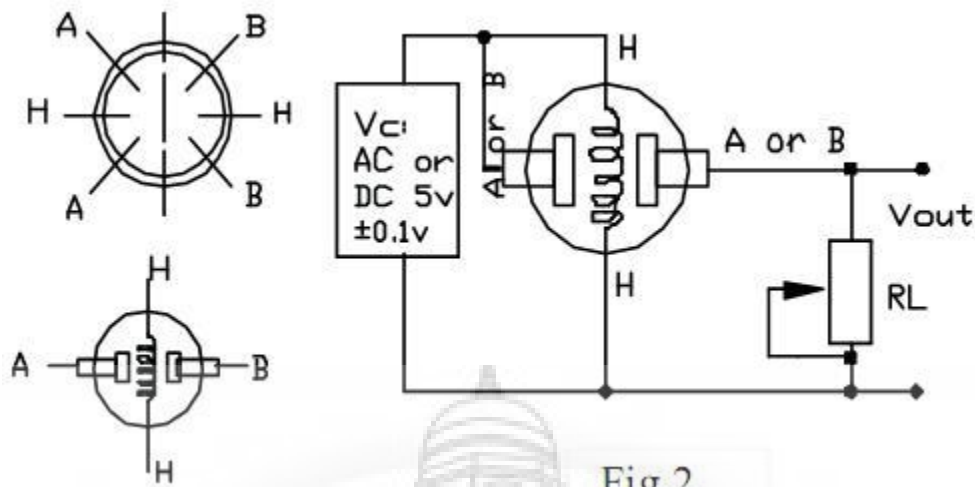

Fig.2

As you can see in the above diagram the MQ series of gas sensors use a small heater inside with an electro-chemical sensor. They are sensitive for a range of gasses.

The preferred wiring is to connect both 'A' pins together and both 'B' pins together. It is safer and it is assumed that it has more reliable output results. Although many schematics and datasheets show otherwise, you are advised to connect both 'A' pins together and connect both 'B' pins together. In the picture, the heater is for +5V and is connected to both 'A' pins. This is only possible if the heater needs a fixed +5V voltage.

The variable resistor in the picture is the load-resistor and it can be used to determine a good value. A fixed resistor for the load-resistor is used in most cases. The sensor needs a load-resistor at the output to ground. Its value could be from $2k\Omega$ to $47k\Omega$. Lower the value, the less sensitive. Higher the value less accurate for higher concentrations of gas.

If only one specific gas is measured, the load-resistor can be calibrated by applying a know concentration of that gas. If the sensor is used to measure any gas (like in air quality detector) the load-resistor could be set for a value of about 1V output with clean air.

Choosing a good value for the load-resistor is only valid after the burn-in time.

Burn-in

Some datasheets use the term "preheat", but it is the time to burn-in the sensor. This is meant to make the sensor readings more consistent. A time of 12 or 48 hours is usually used for the burn-in time.

The Burn-in is achieved by applying normal power to the sensor (to the heater and with the 'A' and 'B' pins connected, and with a load-resistor). In some special cases a specific burn-in is needed. See the datasheet if the sensor needs such a specific burn-in.

Interfacing Circuit

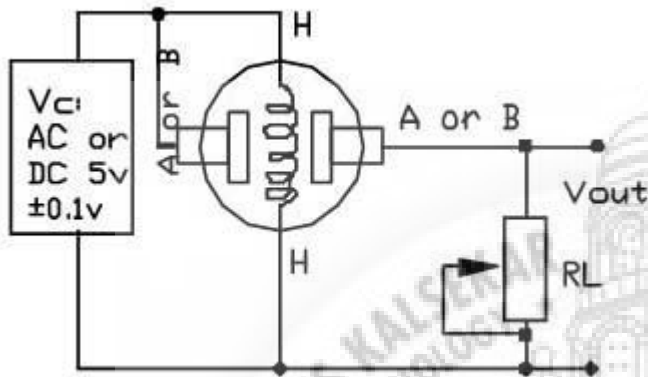

Since the output of the gas sensors is resistive a resistor has to be connected between the output pin and ground as shown in the adjoining circuit. As you can see no other component is required. There is no specific value for the load resistor. Its value could be from $2k\Omega$ to $47k\Omega$. Lower the value, the less sensitive. Higher the value less accurate for higher concentrations of gas. This output voltage can directly be given to any ADC or any comparator circuit and accordingly the gas value can be calculated using a lookup table. These sensors can be easily directly connected to micro controllers with internal ADC or with Arduino.

2.6 POWER SUPPLY

There are many types of power supply. Most are designed to convert high voltage AC mains electricity to a suitable low voltage supply for electronic circuits and other devices. A power supply can be broken down into a series of blocks, each of which performs a particular function.

For example a 5V regulated supply:

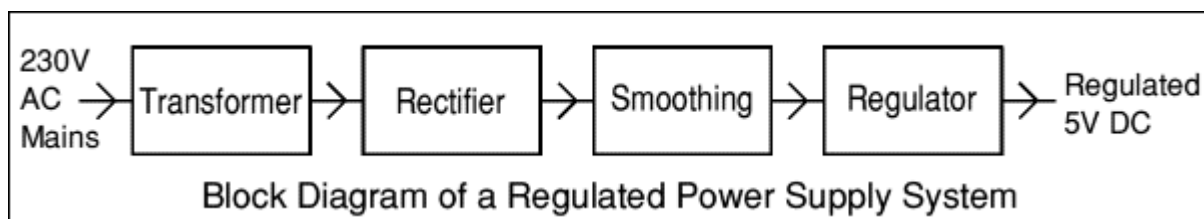

Each of the blocks is described in more detail below

- Transformer - steps down high voltage AC mains to low voltage AC.
- Rectifier - converts AC to DC, but the DC output is varying.
- Smoothing - smoothes the DC from varying greatly to a small ripple.
- Regulator - eliminates ripple by setting DC output to a fixed voltage.

Power supplies made from these blocks are described below with a circuit diagram and a graph of their output:

- Transformer only
- Transformer + Rectifier
- Transformer + Rectifier + Smoothing
- Transformer + Rectifier + Smoothing + Regulator

Transformer only

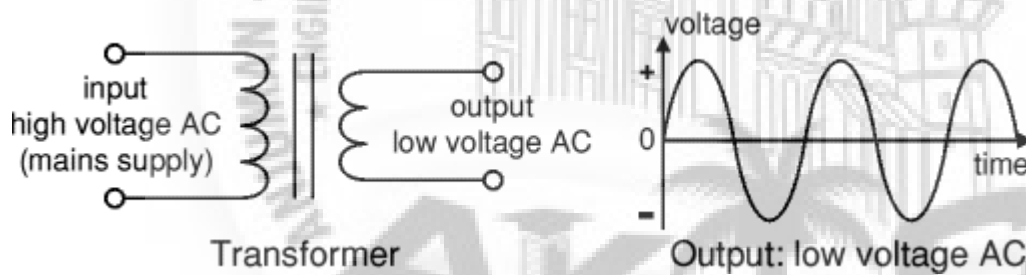

The **low voltage AC** output is suitable for lamps, heaters and special AC motors. It is **not** suitable for electronic circuits unless they include a rectifier and a smoothing capacitor.

. Transformer + Rectifier

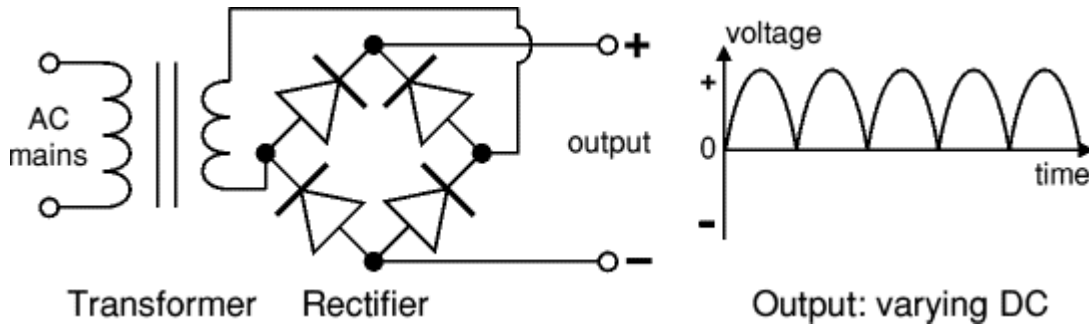

The **varying DC** output is suitable for lamps, heaters and standard motors. It is **not** suitable for electronic circuits unless they include a smoothing capacitor.

- **Transformer + Rectifier + Smoothing**

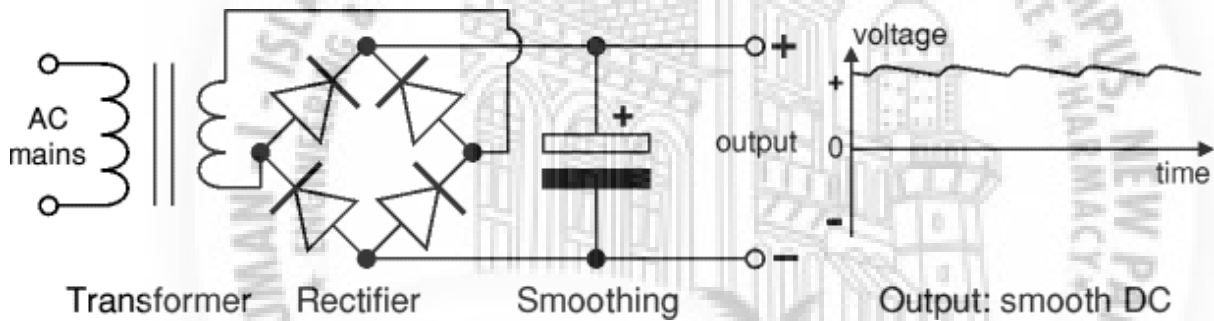

The **smooth DC** output has a small ripple. It is suitable for most electronic circuits.

- **Transformer + Rectifier + Smoothing + Regulator**

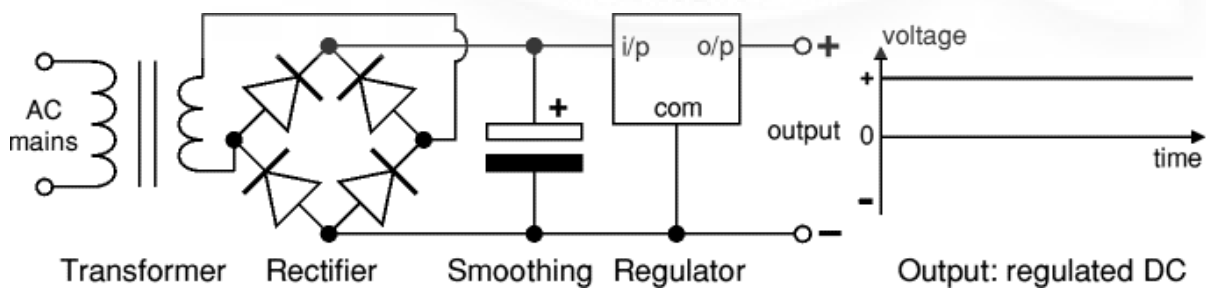

The **regulated DC** output is very smooth with no ripple. It is suitable for all electronic circuits.

The fig. above shows the circuit diagram of the power supply unit. This block mainly consists of a two regulating IC 7805 and a bridge rectified and it provides a regulated supply approximately 5V.

The transformer used in this circuit has secondary rating of 7.5V. The main function of the transformer is to step down the AC voltage available from the main. The main connections are given to its primary winding through a switch connected to a phase line. The transformer provides a 7.5V AC output at its secondary terminals and the maximum current that can be drawn from the transformer is 1 Amp which is well above the required level for the circuit.

The bridge rectified the AC voltage available from the secondary of the transformer, i.e. the bridge rectifier convert the AC power available into DC power but this DC voltage available is not constant. It is a unidirectional voltage with varying amplitude.

To regulate the voltage from the bridge rectifier, capacitors are connected. Capacitors C1 filter the output voltage of the rectifier but their output is not regulated and hence 7805 is connected which is specially designed for this purpose.

Although voltage regulators can be designed using op-amps, it is quicker and easier to use IC voltage regulator. Further more, IC voltage regulators are available with features such as programmable output current/ voltage boosting, internal short circuit current limiting, thermal shut down and floating operation for high voltage applications.

The 78 XX series consists of three terminals viz, input, output & ground. This is a group of fixed positive voltage regulator to give an output voltage ranging from 5V to 24V. These IC's are designed as fixed voltage regulators and with adequate heat sinking, can deliver output current in excess of 1 Amp although these devices do not require external components and such components can be used to obtain adjustable voltage and current limiting. In addition, the difference between the input and output voltages (V_{in} in V_o) called the dropout voltage must be typically 2V even from a power supply filter. Capacitors C2, C3, C4, and C5 are small filters which are used for extra filtering. LED1 & LED2 are used for Power ON indicator for IC1 and IC2, current-limiting resistors R2 & R4, which prevents the LED's from getting heated and thus damaged.

CHAPTER 3

CIRCUIT DIAGRAM

3. CIRCUIT DIAGRAM

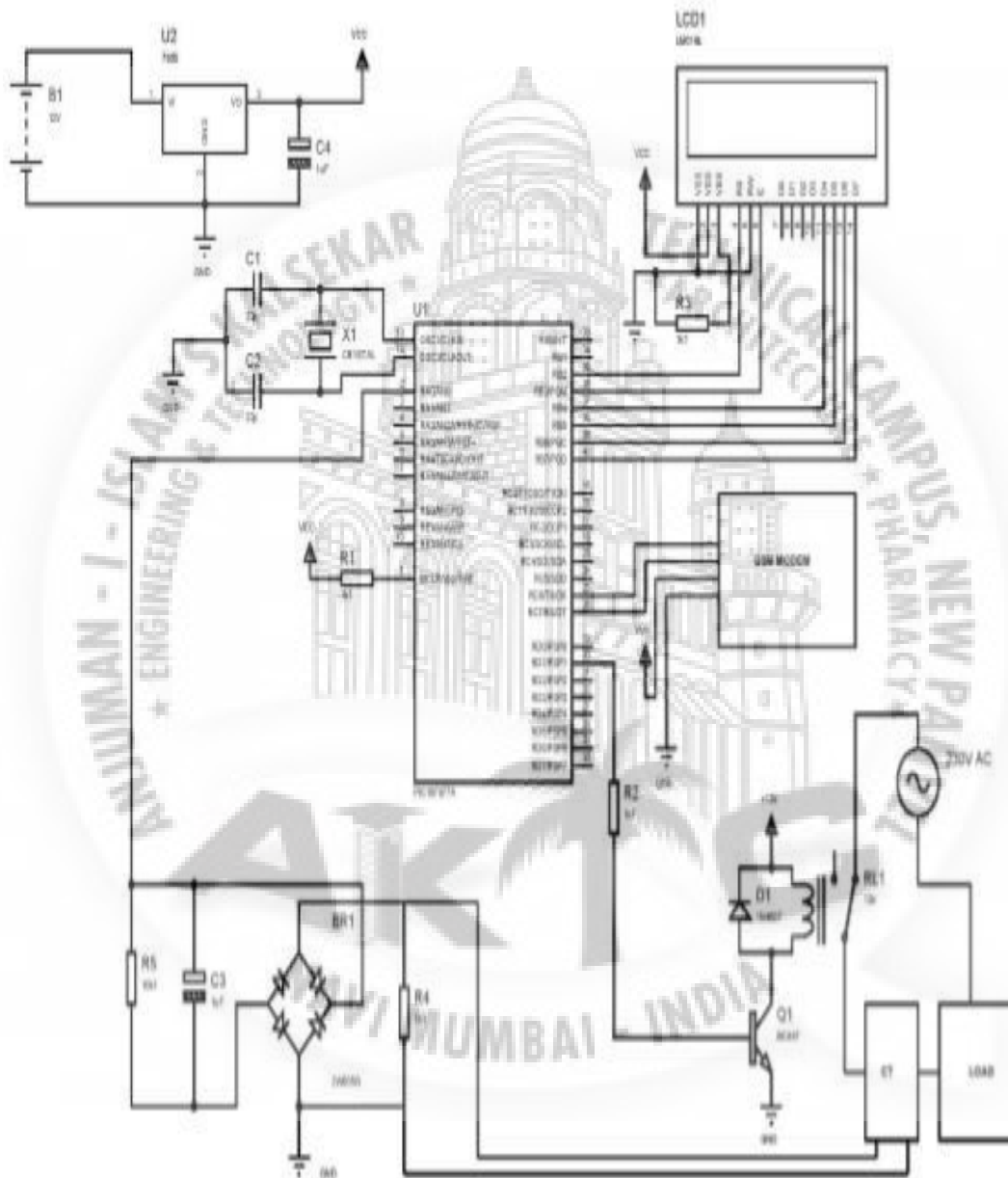

Fig Circuit Diagram

The PIC16877A is a central part of the circuit. The GSM module is connected to pin 25 and 26 of the PIC microcontroller to send and receive messages. The supply and ground pins of the GSM module are connected to the main supply and neutral. A current transformer is connected in the main circuit. This current transformer senses the current passing through the main circuit and steps it down to a smaller value. This current is passed through a resistor and the corresponding voltage drop is taken. This voltage is rectified using a bridge rectifier and the output is filtered. This dc voltage is given to the pin 2 of the PIC microcontroller. This dc voltage is configured to be less than 5V as the PIC microcontroller cannot have an input greater than 5V. An external clock circuit is connected to pins 13 and 14 of the microcontroller. An LCD is used to display the status of the circuit breaker. Pins 35-40 of the microcontroller are connected to the LCD. The normally open terminals of a relay are connected in series with the main circuit. Pin 20 of the PIC microcontroller is connected to the base of a transistor. This transistor is used to drive the relay. A battery pack is provided to the system to keep the PIC microcontroller in operation in the event of a power failure.

When any fault occurs such as an overload or a short circuit, the microcontroller detects it and immediately trips the relay. The status of the breaker is displayed on the LCD and the appropriate message is sent to the user via the GSM module. The supply can then be resumed either manually or remotely. The user can send a preset value such as a dollar sign via SMS to the circuit breaker to restore the supply. The microcontroller on receiving the message checks it for a dollar sign and on finding it, recloses the relay.

The main power supply is given directly to load and step down transformer. 230 volt is Step down to 12v and then we use diodes which act like a rectifier to convert ac to dc and passed through 7805 regulator to get 5v supply for microcontroller, capacitor filters are used to remove the ripples to get pure constant 5v dc voltage. In this project, we are protecting our circuit from excessive load current. As load increases then device get OFF otherwise it remains in its original state. For that, we are using opto-coupler. Load connected with opto-coupler. If there is single load then circuit works properly. If load increases then current rating increases that get fire the opto-coupler. Due to firing, opto-coupler gives low voltage to the op-amp through which it is connected. Op-amp connected with microcontroller. Output of opamp applies to controller. If output is low then controller show "DEVICE ON" message. If output is high then the preset value then the controller show "DEVICE OFF" message. In this project message is displayed through LCD. As device on then relay get ON else relay get off

3.2 FUTURE OF CIRCUIT BREAKER

Engineers have long considered circuit protection a stable if somewhat unglamorous area. However, that stability is diminishing rapidly. New sophisticated devices reshape the way engineers apply circuit protection and open new possibilities for the savvy designer. Electronic systems are shrinking and circuit-protection devices are no exception. To take up less space, circuit breakers may double as power-control relays. Programmability has also come to circuit breakers. Smartprotectors sport programmable trip values and overload time delays. More-sophisticated protectors measure and report voltage and current values, alert control systems about tripped conditions, and can be reset remotely. Breakers can be classified into magnetic and thermal types. Magnetic breakers operate via a solenoid that trips a mechanism at almost the instant it sees a threshold current. The near instantaneous response is appropriate for printed-circuit boards and sudden power surges as from short circuits or emergency shutdowns from crowbar-type overvoltage monitors. Magnetic breakers often get paired with hydraulic delays to tolerate current surges as generated during motor startup. Mounting the breaker horizontally keeps gravity from influencing solenoid movement. Breakers mounted vertically may need derating. Magnetic breakers have a reputation for low voltage losses. The solenoid coil they use has little resistance resulting in low I R drop. Thermal or thermalmagnetic breakers generate heat that is applied to a bimetallic strip or disk. This heating mechanism generally produces a higher voltage drop though not as high as engineers tend to assume.

Thermal breakers rated under 5 A generally add more resistance to the power circuit than equivalently rated magnetic breakers. But many thermal breakers rated 5 A or higher have the same or lower resistance than magnetic breakers. So nothing precludes the use of these higher-rated thermal breakers if the application would benefit.

The bimetallic strip in a thermal breaker consists of two metals with different coefficients of expansion. As the strip heats one metal expands more than the other to warp the strip. The warped strip either opens a set of electrical contacts directly or triggers a mechanism to trip out the breaker. The thermal lag from heating the bimetallic strip gives thermal breakers a slower trip. The slow-trip response helps discriminate between safe temporary surges and prolonged overloads. These breakers work best for machinery or vehicles where high inrush current accompanies the start of electric motors, transformers, and solenoids. As global markets become more important, designers must consider how circuit-protection devices can meet both domestic and international standards. Traditional UL and CSA product approvals may not suffice. Engineers and designers may need to consider VDE, the German Association for Electrical, Electronic,

and Information Technology, or the broader European CE mark for products sold in European Union countries. On the other side of the world the CCC mark, or China Compulsory Certification, is mandatory for products exported to or sold in China. CCC approval covers low-voltage electrical products including circuit breakers, electric tools, household appliances, and telecom equipment. Embedded microprocessors now get built into a variety of products, and circuit-protection products are no exception with the arrival of intelligent devices. Many smart breakers include sensing circuits. These sensors feedback information to PLCs or other control units on such factors as circuit status, current flows, and other relevant data. Some solid-state circuit breakers provide an analog output signal proportional to current. Programmable technology using solid-state power control makes it possible to monitor and limit maximum current flow during short circuits. Embedded microcontrollers let engineers program both breaker trip points and speed profiles on the fly. A small amount of processing power and the ability to communicate via standard industrial networks makes remote programmability a reality today.

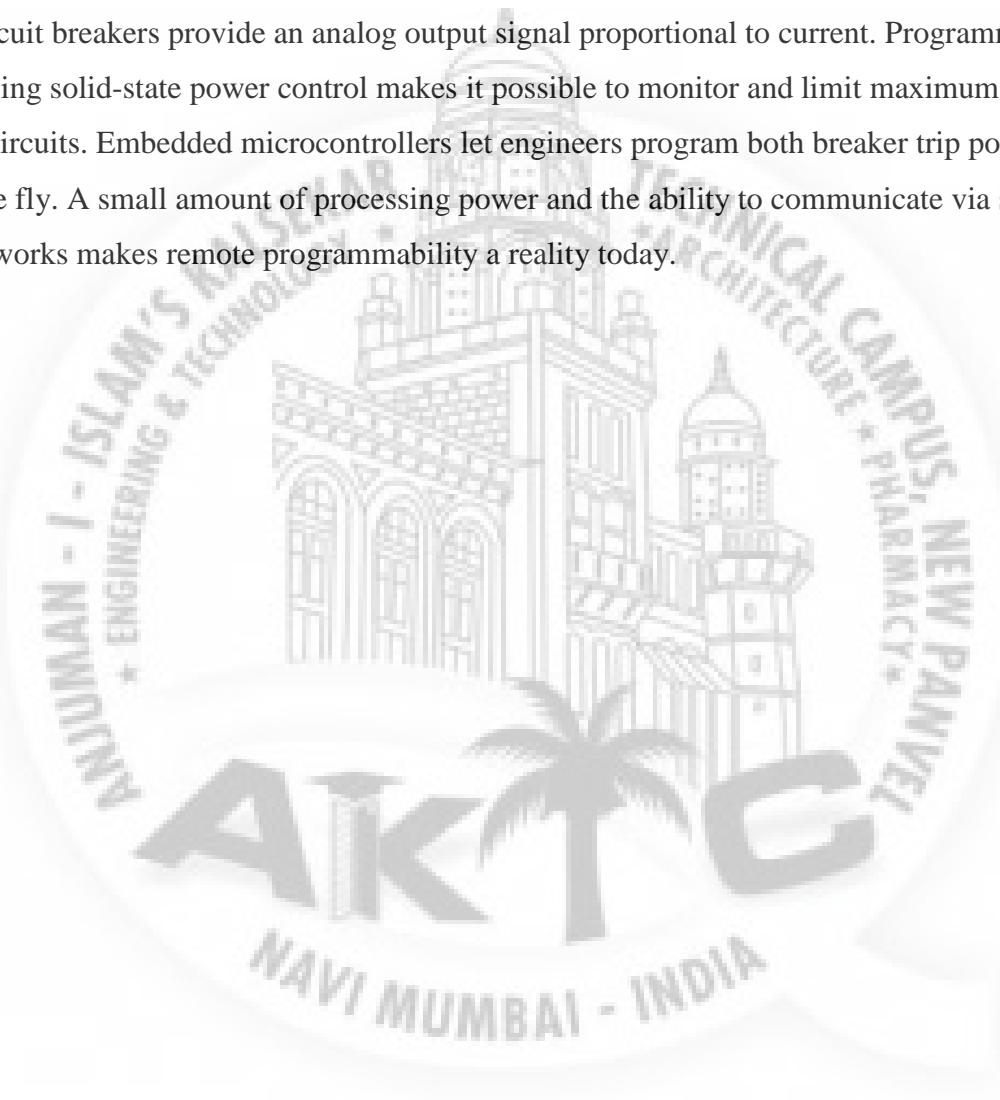

CHAPTER 4

COMPARISON

4.1 COMPARISON

The solenoid coil used in magnetic breakers has little resistance producing minimal voltage drop. In general, the heating mechanism in thermal and thermal-magnetic breakers adds more resistance to the power circuit producing a higher voltage drop. However, many thermal breakers rated 5 A or higher provide no more resistance than magnetic breakers. Another tradeoff between thermal and magnetic breakers is shock and vibration resistance: because of their moving masses and swinging armatures, magnetic breakers are more likely than thermal breakers to trip if there is a physical disturbance.

4.2 SMART CIRCUIT PROTECTION

Today's manufacturers of electrical and electronic equipment are under constant pressure to speed up design cycles, cut part counts, reduce size, increase functionality, and improve reliability. Products must be small, quick to install, and easy to replace in the field, all while saving cost. Circuit protection devices are no exception, and these requirements have been met by the emergence of "smart" devices. The addition of embedded microprocessors has brought intelligence, programmability, and communications capabilities to circuit-protection products, creating a new class of devices that can protect equipment more effectively. Programmable technology using solid-state power control makes it possible to monitor and limit current flow during short circuits, retrieve high current values, cycle times, and other information from breakers with internal memory storage. It also allows design engineers to program breaker trip points and speed profiles necessary to meet the applications specifications. Many smart breakers include sensing circuits that feed information such as voltage values, current flows, and circuit status back to PLCs or other control units and can be reset remotely. Some also provide an analog output signal proportional to current. Another benefit of using electronic circuit protection devices is the space saving afforded by having breakers do double duty as power control relay. Smart circuit breakers offer all the features of a solid state relay in addition to over current trip features of a circuit breaker.

4.3 LIGHT SENSOR (LDR)

Various types of Light Sensors are available in the market. One of the most common type & cost effective type of Light sensor is a Light Dependent Resistor abbreviated as LDR. A LDR is also called as photo

resistor or photocell. It is basically a variable resistor whose resistance varies according to the light intensity falling on it. The resistance of the LDR can be few Mega Ohm's ($M\Omega$) in dark conditions, and in Light condition the resistance can be of several hundred ohm's. LDR's are less sensitive to lights as compared to photo-transistors or Photo-diodes. Photo-transistors or Photo-diodes are active components with P-N Junction whereas the LDR is a passive component. The ZigZag Pattern of the LDR on the ceramic Substrate increases the dark resistance.

LDR has no polarity just like a resistor. The resistance of LDR can be very easily measured by just connecting the two terminals of LDR to a multimeter & set the multimeter on resistance Mode. Now when you change the intensity of light falling on the LDR you can see the resistance varying. LDR is available in various sizes e.g. 5mm LDR & 12mm LDR where the substrate of the LDR is 5mm wide and 12mm wide respectively.

The resistance of LDR can be different for different LDR's and is dependent on the light sensitive material used making it. Several different materials are used as semiconductor substrate for different applications. For mid-infrared spectral region Lead sulphide (PbS) and indium antimonide (InSb) are used. For infrared region used in infrared astronomy and infrared spectroscopy Ge:Cu photo conductors are used. And the most commonly used is Cadmium Sulphide (CdS) because it is inexpensive and is sensitive to wavelength range from 400nm – 850nm i.e. the visible spectrum.

The CdS LDR is a very low cost sensor and is used in lot of day to day applications ranging from turning Street lights ON/OFF, Dusk dawn switch, LED emergency Lights to camera light meters.

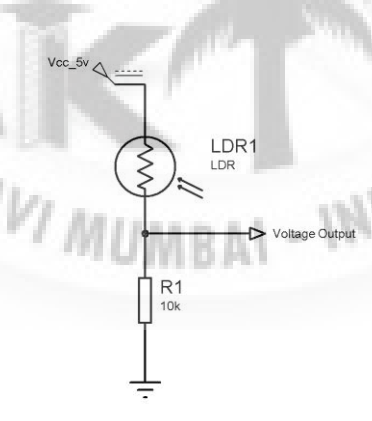

Fif Interfacing of LDR

The output of LDR is resistance hence it cannot be connected directly to any ADC. So a voltage divider circuit has to be constructed. You can see a simple voltage divider circuit whose output voltage is proportional to the light intensity of the light falling on the LDR. This output voltage can then be given directly to an ADC to measure the light intensity or to a comparator circuit.

$$V_{out} = V_{in} \times (R_1 / (R_1 + R_{LDR}))$$

V_{out} = Output Voltage of Voltage Divider Section

V_{in} = Input Voltage of Voltage Divider Section in our condition its 5 Volts

R_{LDR} = Resistance of LDR

Circuits Based on LDR

- Arduino Based Dark Switch
- Light Activated Switch using LM555 & LDR

Advantages of LDR

- Low cost & Easily Available
- Easy to Use.

Disadvantages of LDR

- Slow Response time as Compared to Photo Diodes.

The switching action can be inverted, so the LED lights when the LDR is brightly lit, by swapping the

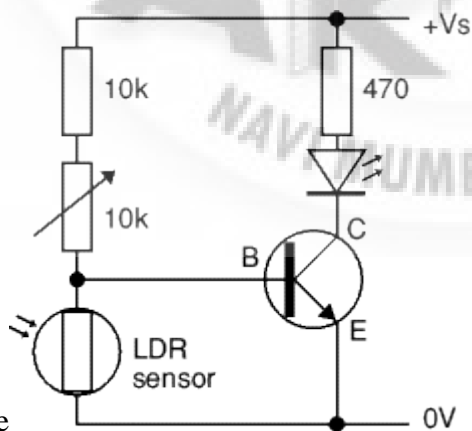

LDR and variable resistor. In this case the fixed resistor can be omitted because the LDR resistance cannot be reduced to zero.

Note that the switching action of this circuit is not particularly good because there will be an intermediate brightness when the transistor will be **partly on** (not saturated). In this state the transistor is in danger of overheating unless it is switching a small current. There is no problem with the small LED current, but the larger current for a lamp, motor or relay is likely to cause overheating.

Other sensors, such as a thermistor, can be used with this circuit, but they may require a different variable resistor. You can calculate an approximate value for the variable resistor (R_v) by using a multimeter to find the minimum and maximum values of the sensor's resistance (R_{min} and R_{max}):

Variable resistor, $R_v = \text{square root of } (R_{min} \times R_{max})$

For example an LDR: $R_{min} = 100\Omega$, $R_{max} = 1M\Omega$, so $R_v = \text{square root of } (100 \times 1M) = 10k\Omega$.

You can make a much better switching circuit with sensors connected to a suitable IC (chip). The switching action will be much sharper with no partly on state.

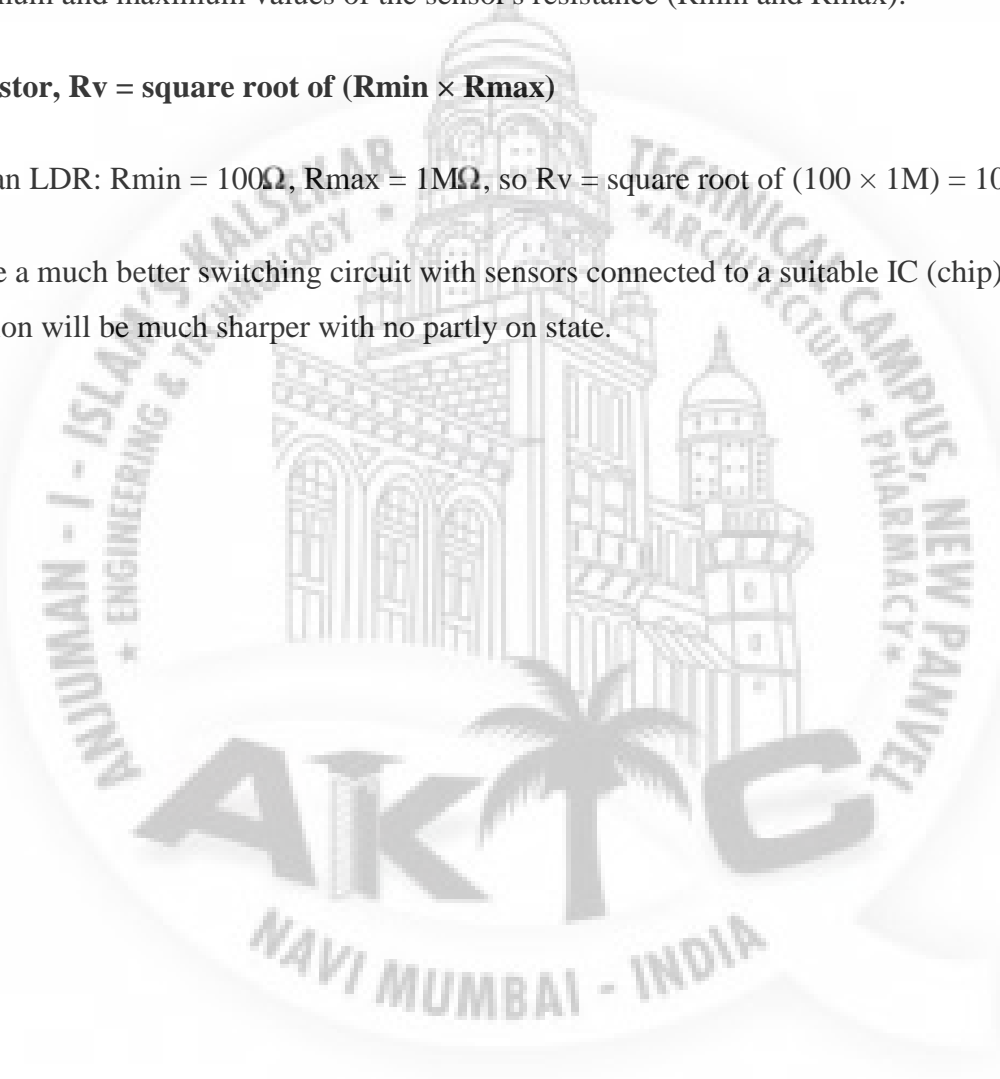

CHAPTER 5

HARDWARE TESTING

5.1 CONTINUITY TEST:

In electronics, a continuity test is the checking of an electric circuit to see if current flows (that it is complete circuit). A continuity test is performed by placing a small voltage (with multimeter) across the chosen path. If electron flow is inhibited by broken conductors, damaged components, or excessive resistance, the circuit is "open".

Devices that can be used to perform continuity tests include multimeter which measure current and specialized continuity testers which are cheaper, more basic devices, generally with a simple light bulb that lights up when current flows. An important application is the continuity test of a bundle of wires so as to find the two ends belonging to a particular one of these wires; there will be a negligible resistance between the "right" ends, and only between the "right" ends.

This test is performed just after the hardware soldering and configuration has been completed. This test aims at finding any electrical open paths in the circuit after the soldering. Many a times, the electrical continuity in the circuit is lost due to improper soldering, wrong and rough handling of the PCB, improper usage of the soldering iron, component failures and presence of bugs in the circuit diagram. We use a multi meter to perform this test. We keep the multi meter in buzzer mode and connect the ground terminal of the multi meter to the ground. We connect both the terminals across the path that needs to be checked. If there is continuation then you will hear the beep sound.

5.2 POWER ON TEST:

This test is performed to check whether the voltage at different terminals is according to the requirement or not. We take a multimeter & put it in voltage mode. Firstly, we check the output of the transformer, whether we get the required 12 v AC voltage.

Then we apply this voltage to the power supply circuit. Note that we do this test without microcontroller because if there is any excessive voltage, this may lead to damaging the controller. We check for the input to the voltage regulator i.e., are we getting an output of 12v. Similarly, we check for the other terminals for the required voltage. In this way we can assure that the voltage at all the terminals is as per the requirement

CHAPTER 6

RESULTS

6.1 RESULTS

The main power supply is given directly to load through CT and step down transformer 230 v to 12v, and supplied to regulate supply unit which consist of bridge rectifier to convert ac to dc and passed through 7812 regulator to get 12v supply for working of IC LM324, capacitor filters are used to remove the ripples to get pure constant dc voltage. The current passing to load is sensed by the current transformer and output of CT.

The current sensed is compared with the inbuilt comparator of which as pre-set reference value. If the current sensed is less than the pre-set value than TRANSISTOR will be in OFF state and relay will not trip the supply to load. As we increase the load current drawn is more so if the current is increase than the pre-set value than TRANSISTOR will turn ON and energizes the relay. Thus LED used as an Indicator is properly biased, and it glows. The relay coil gets energized, causing the armature to shift its position to the normal open point from the normal closed point. The AC supply to the load is thus cut off from the load within 15micro sec to 30microsec and the load is tripped. Once the circuit is tripped it must be reset for further use using reset button. In case of normal operation microcontroller will pin will receive 12v dc from regulator.

6.2 CONCLUSION

Now A days the protection and control of equipment plays a very important role. To avoid electrical failure we use fast responding circuit breakers because of its considerable accuracy in fault detection and cut off- time, and also its smooth operation compared to conventional type. Comprehensive experiments conducted by constructing the necessary circuit yielded successful results. It was proved that electronic circuit breaker is very useful circuit for sensitive loads. The main advantage of this circuit is that over all tripping time is less as compare to conventional circuit breaker. The experiment is successful and energy saving. Further research on improving the load capacity and tripping time is being undertaken.

6.2 FUTURE SCOPE

The operating time of electromagnetic relay can be improved by using sophisticated electronic components

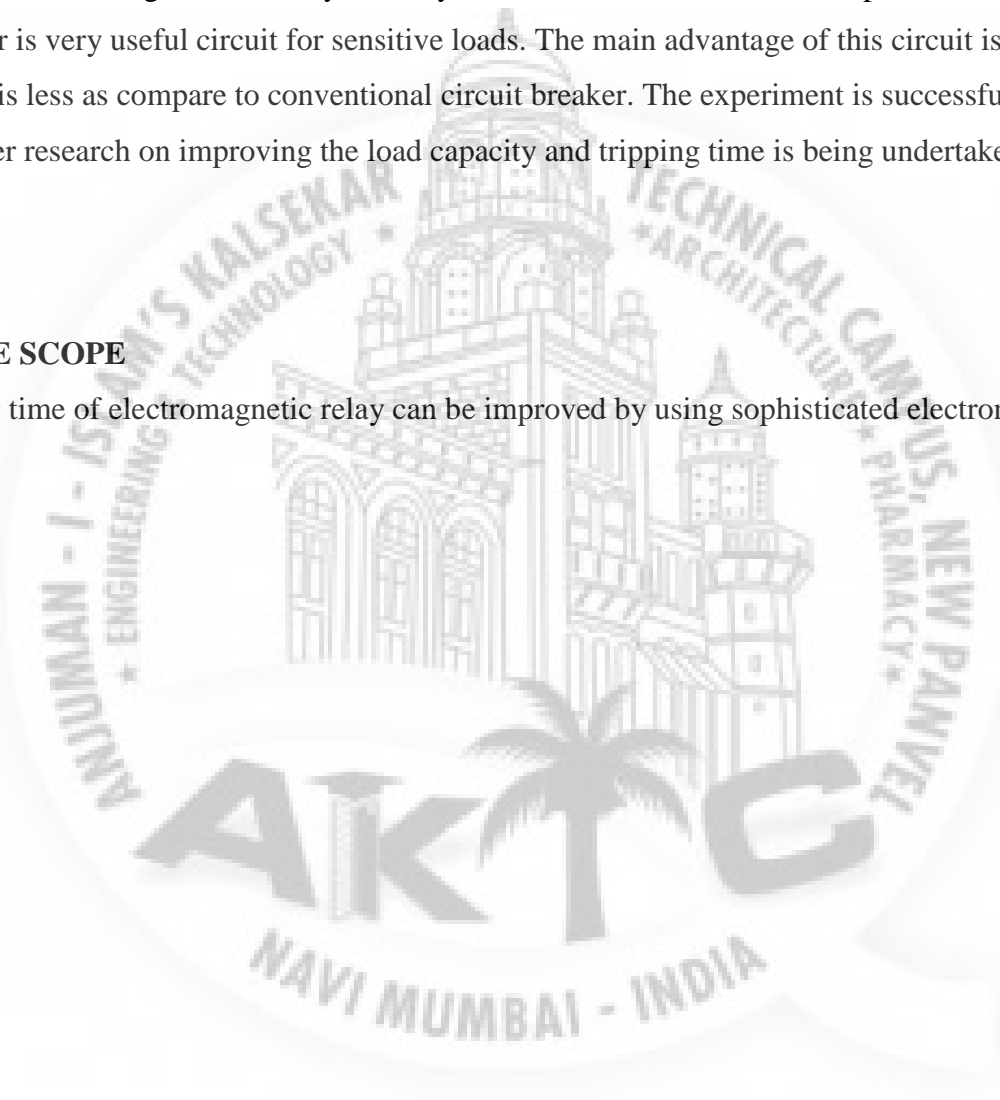

CHAPTER 7

REFERENCES

- [1]. Francesco Bittoni Guido Fiesholi, Lorenzo, Cincinelli “Electronic Circuit Breaker”, Patent# Wo 2004/082091 A1 September 2012.
- [2]. J. Meyer, A Rufer, “DC Hybrid CB with ultra fast contact opening with IGCT”, IEEE transactions on power delivery, April 2006.
- [3]. International Journal of Scientific Engineering and Technology Research, Ultra Fast Acting Electronic Circuit Breaker, Volume.04, Issue No.11, May-2015, Pages: 2130- 2131.
- [4]. T. Genji, Nakamar: high speed circuit Breaker for electric power system.

WEBSITES

- www.atmel.com
- www.beyondlogic.org
- www.wikipedia.org
- www.howstuffworks.com
- www.alldatasheets.com