

A  
Project Report  
on  
**“JOHN BEDINI’S FREE ENERGY GENERATOR”**

Submitted in partial fulfillment of the requirements  
of the degree of  
Bachelor of Engineering in Electrical Engineering

Submitted by

Naik Saif Ali (15DEE02)

Waghu Faizan (15DEE07)

Sayed Aquib (15DEE13)

Naik Asif (15DEE17)

Under the guidance of

Prof. Shraddha Amin

**DEPARTMENT OF ELECTRICAL ENGINEERING**

Anjuman-I-Islam

Kalsekar Technical Campus

New Panvel 410206

**University of Mumbai**

## CERTIFICATE

Certified that the project report entitled “**JOHN BEDIN'S FREE ENERGY GENERATOR**” is a bonafied work done under my guidance by

- Naik Saif Ali (15DEE02)
- Waghu Faizan (15DEE07)
- Sayed Aquib (15DEE13)
- Naik Asif (15DEE17)

During the academic year **2017-18** in partial fulfillment of the requirements for the award of degree of **Bachelor of Engineering in Electrical Engineering** from **University of Mumbai**.

Date-

Approved by-

(Prof. SHRADDHA AMIN)

Guide

(Prof. SYED KALEEM)

(Dr. ABDUL RAZZAK)

Head of Department

Director

## CERTIFICATE OF APPROVAL

The foregoing disseration entitled “**JOHN BEDINI’S FREE ENERGY GENERATOR**” is hereby approved as a creditable study of Electrical Engineering presented by

- Naik Saif Ali (15DEE02)
- Waghu Faizan (15DEE07)
- Sayed Aquib (15DEE13)
- Naik Asif (15DEE17)

In a manner satisfactory to warrant is acceptance as a pre-requisite to their Degree in Bachelor of Electrical Engineering.

Internal Examiner  
(Prof. Shraddha Amin)

External Examiner

## DECLARATION

I declare that this written submission represents my ideas in my own words and where others ideas or words have been included, I have adequately cited and referenced the original sources. I also declared that I have adhered to all principles of academic honesty and integrity and have not represented or fabricated or falsified any idea/data/fact/source in my submission. I understand that any violation of the above will be cause for disciplinary action by the Institute and can also evoke penal action from the sources which have thus not been properly cited or from whom proper permission have not been taken when needed.



(Signature)

(Name of student and Roll No.)

Date-

## ACKNOWLEDGEMENT

It gives me immense pleasure to present this project on “JOHN BEDINI’S FREE ENERGY GENERATOR” carried out at AIKTC , New Panvel in accordance with prescribed syllabus of University of Mumbai for Electrical Engineering. I express my heartfelt gratitude to those who directly and indirectly contributed towards the completion of this project. I would like to thanks Mr. Abdul Razzak, Principal, ACEM for allowing me to undertake this guide Prof. Shraddha Amin for continuous support. I would like to thanks all the faculty members, non-teaching staffs of Electrical Engineering of our College for their direct and indirect support and suggestion for performing the project.

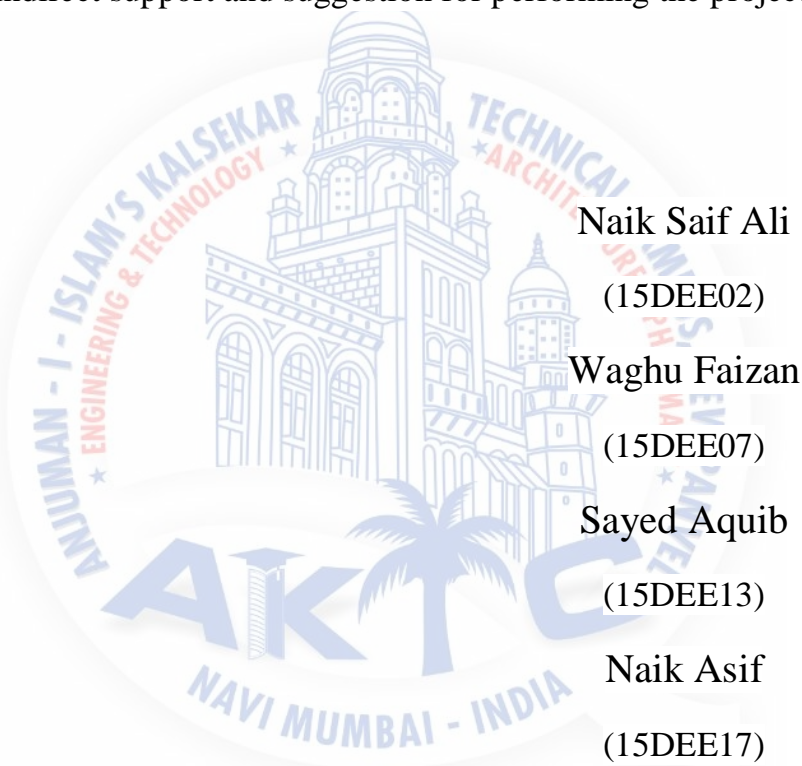

Naik Saif Ali

(15DEE02)

Waghu Faizan

(15DEE07)

Sayed Aquib

(15DEE13)

Naik Asif

(15DEE17)

## Abstract

The main aim of the project is to Generate electricity without using any fuel. Actually, "electrical science" is well aware of the little voltage spike that appears in a circuit when an energized coil of wire is disconnected from its source of current.

This phenomena is generally considered to be:

- 1) a nuisance that
- 2) can damage electronic components in the circuit
- 3) unless it is gotten rid of somehow.
- 4) It is also generally believed to have no significant amount of energy associated with it, other than the "over-voltage" condition it may momentarily produce.

In this project, we will consider this little voltage spike to be:

- 1) of the highest importance to understand
- 2) and to take advantage of it
- 3) for the recovery of its real, yet under-appreciated, energy content.

In this project we will be using an electronic circuit having resistor diode and transistor Network to utilize that voltage spike to charge a battery.

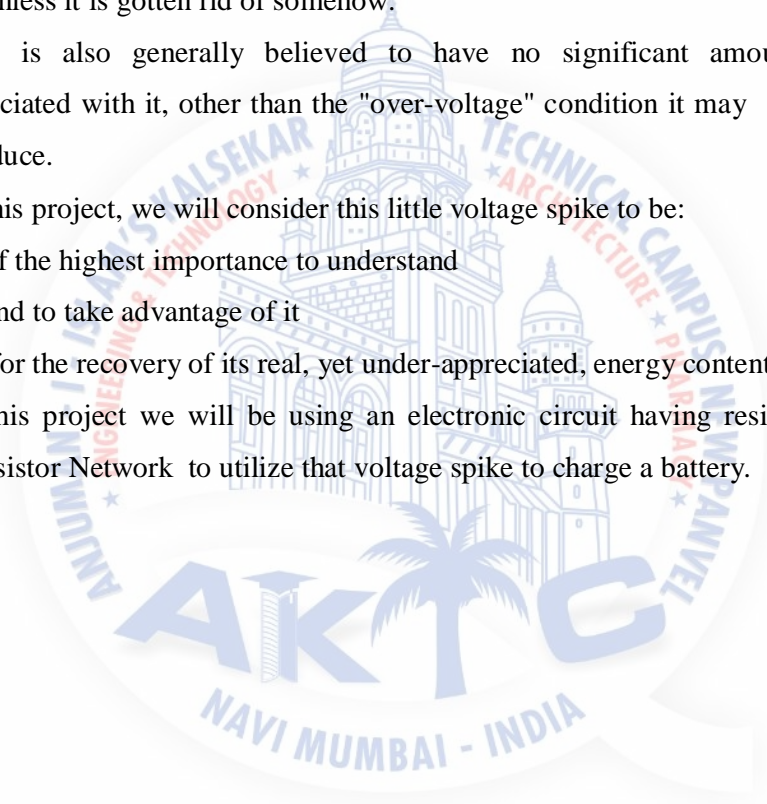

# CONTENTS

<b>Title</b>	<b>Page no.</b>
Name	
Certificate	
Certificate of Approval	
Declaration	
Acknowledgement	
Abstract	
Contents	
1. Introduction	1-2
2. Literature survey	3-4
3. Block Diagram	5-6
4. Working	9
4.1 Working Principle	7-10
4.2 Optimizing Energy Recovery	11-12
4.3 Two Modes Of Running	13-18
4.4 Electronic Components Required	19-20
5. Advantages and Application	21
5.1 Advantages	21
5.2 Application and Future Scope	21
6. Conclusion	22
7. References	23

# Chapter 1

## Introduction

Since the device operates on electricity and it mechanically spins during its operation, most people think of it as an "electric motor." To be perfectly clear, the device IS NOT an electric motor. John has always, from the very first, referred to the device as a "self-rotating energizer" or simply as an "energizer." This distinction is extremely important if you are to understand this project.

Electric motors are usually designed to power some other rotating device, like a pump or a compressor. This is NOT the primary purpose of the Bedini SG Energizer, as we will see shortly. It's true that it does spin and it does produce a small amount of mechanical energy. But the way it does this is very different than most electric motors and its ability to power other mechanical loads is quite limited. Actually, "electrical science" is well aware of the little voltage spike that appears in a circuit when an energized coil of wire is disconnected from its source of current. This phenomena is generally considered to be: 1) a nuisance that 2) can damage electronic components in the circuit 3) unless it is gotten rid of somehow. 4) It is also generally believed to have no significant amount of energy associated with it, other than the "over-voltage" condition it may momentarily produce.

In this project, we will consider this little voltage spike to be: 1) of the highest importance to understand 2) and to take advantage of it 3) for the recovery of its real, yet under-appreciated, energy content.

Except for this one difference concerning the significance and character of the voltage spike event, this project conforms to all other classical electrical engineering and circuit design methods. So, let's look at the energy recovery methods in this situation as we scale the project up to the next level.

Since the device operates on electricity and it mechanically spins during its operation, most people think of it as an "electric motor." To be perfectly clear, the device IS NOT an electric motor. John has always, from the very first, referred to the device as a "self-rotating energizer" or simply as an "energizer." This distinction is extremely important if you are to understand this project.



Electric motors are usually designed to power some other rotating device, like a pump or a compressor. This is NOT the primary purpose of the Bedini SG Energizer, as we will see shortly. It's true that it does spin and it does produce a small amount of mechanical energy. But the way it does this is very different than most electric motors and its ability to power other mechanical loads is quite limited.

The true purpose of the device is to have a very specific effect on the battery that is powering it, and to keep itself rotating! This is what it does.

So, it is not an electric motor.



## Chapter 2

### Literature Survey

John Bedini is one of the true "living legends" of the Free Energy movement. Starting from a very young age, John always wanted to build a self-running combination of an electric motor and an electric generator. Being told it was "impossible," even hundreds of times, did not deter him.

By 1984, John published his first book on the subject titled Bedini's Free Energy Generator. In this book, John describes how to connect an ordinary electric motor to a specially designed "energizer" and switching circuit to produce a self-running machine that charges its battery while running. Multiple working models were shown at a "Tesla Conference" in Colorado Springs, Colorado in the same year.

This first success did not produce the results that John was looking for. The large model shown at the conference was built by Jim Watson. Immediately after the conference, Jim's machine was "confiscated" and Jim was forced to take a multi-million dollar "pay-off" to quit working on it. Shortly thereafter, John was "roughed-up" in his own shop and told he would "buy gasoline for the rest of his life, or else...." For the next 17 years, John continued to work on his ideas, but only built toy-sized models and rarely showed them to anyone except close friends. Then in 2001, a very interesting thing happened. The father of a 10 year old school girl, who worked in a shop a few doors down from John's shop, came over to ask for some help with his daughter's science fair project.

Having an interest in helping younger folks learn about his technologies, John coached the girl, named Shawnee Baughman, on how to build a small energizer, based on his designs.

The energizer that Shawnee built ran on a little 9 volt battery for over a week, all the while lighting up an LED and spinning a rotor at high speed. She even had a series of posters explaining why it worked.

The machine absolutely infuriated the science teachers, because they could not explain why the battery was not running down! But the other teachers and students loved it, and she won "Best of Show" by popular demand! This was the advent of what became known as the "Bedini School Girl" energizer or the "Bedini SG" for short. News spread fast around the older internet boards and Jeane Manning, a journalist and writer for Atlantis Rising magazine,

wrote an article about Shawnee's energizer, including other details about John Bedini's energy technologies and experiences. This article was called The Attractions of Magnetism, Could a Little Child Be Leading Us to a Free Energy Future?

In the last 11 years, the Bedini SG has become the best known and most replicated Free Energy machine on the planet. For beginners in the field, it has become somewhat of a right-of-passage. Unless you have built one and learned what it has to teach, the nature of these discoveries will remain a mystery. It is quite simply THE project to start with.

Recently, John consolidated several of his energizer internet discussion groups into one new forum for people to visit and learn about his technology. You can visit or join this forum for free at <http://energyscienceforum.com>.

Although there is a huge data base of information on-line, where people can learn about this for free, a simple, authoritative book & video package has been requested for many years. The on-line forums contain a lot of experimental ideas and variations on a theme. But it is an awful lot of material to dig through. People getting involved for the first time now, just want to know how to do it right the first time. Hence, the release of this Complete Beginner's Handbook.

This book is what we all wanted to have in the early days. It explains the history, gives the schematics and parts lists, explains the theory, and reviews all of the variations of this amazing "do-it-yourself" project. So, welcome to the club! We hope that the experience of learning about the Bedini SG is as rewarding and enriching for you as it was for us.

## Chapter 3

### Block Diagram

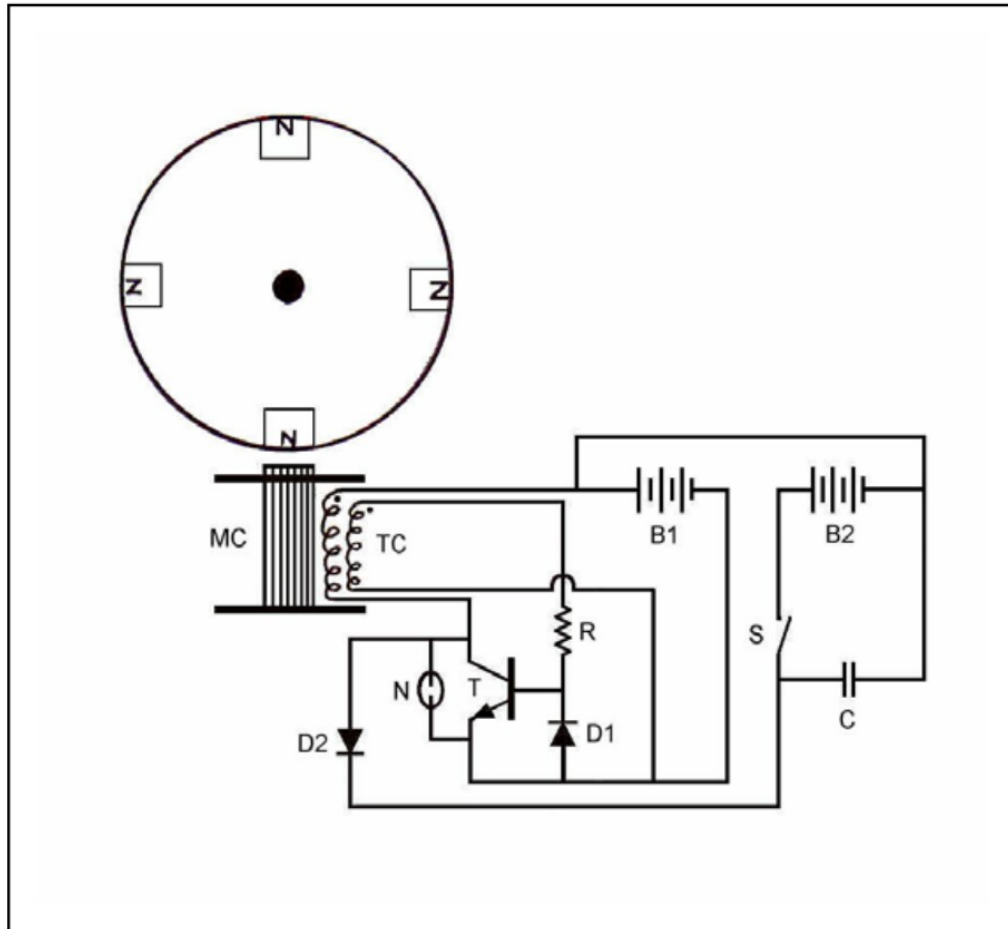

Fig:3 Block Diagram

## Block Diagram Description

The basic block diagram of our project contains

- 1) Rotor
- 2) Main coil (MC) and Trigger coil (TC)
- 3) Batteries (B1 & B2)
- 4) Resistor (R) , Diodes (D1 & D2), Transistor (T)
- 5) Capacitor (C), Switch (S)
- 6) Neon Bulb (N)

The rotor consist of four permanent magnets. The North Pole of the magnet is facing outward. The stator consist of an iron core on which bifilar coil is provided. Bifilar coil means it has two wires of different gages. In the block diagram we can see there are two batteries provided. Battery B1 is the main battery and the battery B2 is the Charging battery. The Diode, Resistor And Transistor make a circuit which utilizes the little voltage spike to charge the battery. The NEON LIGHT is placed directly across the output terminals of the transistor that is turning the coil ON and OFF from the battery. This way, when the transistor turns OFF, the voltage spike can create a temporary pathway back to the battery AFTER the voltage rises high enough to turn the NEON LIGHT ON. Otherwise, when the Neon Light is OFF, no circuit connection is being made. A capacitor and a switch is provided for smooth charging of capacitor.

# Chapter 4

## Working

### 4.1 Working Principle

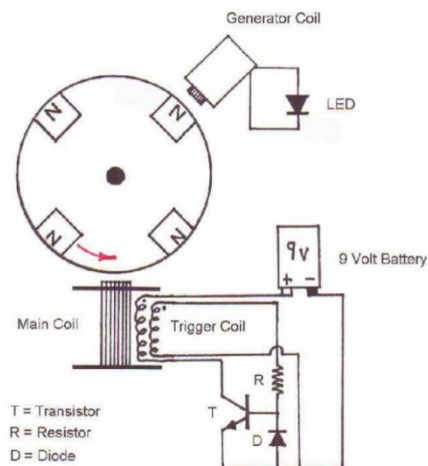

Fig 4.1.1

The Main Coil has some iron rods in the center of its structure and they participate in getting the process started. As one of the magnets on the wheel approaches the iron core of the Main Coil, it becomes attracted to the iron and so, it moves in the direction of the RED ARROW.

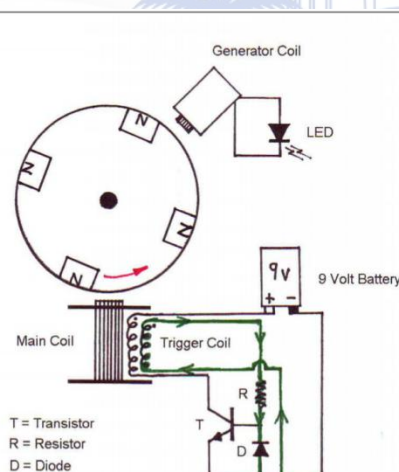

Fig 4.1.2

As the magnet gets closer and closer, the iron rods start to magnetize and as they do that, a small current is induced in the Trigger Coil winding that flows in the loop indicated by the GREEN ARROWS. With the coil wound "clockwise", this current flow is in the wrong direction to activate the transistor, so the transistor stays OFF during the approach of the

magnet. This means that while the magnet is approaching the Main Coil, the transistor is OFF and no power is being drawn from the 9 volt battery.

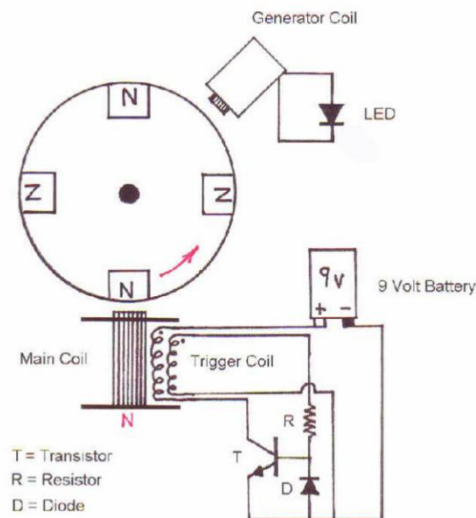

Fig 4.1.3

Mechanical energy is being produced and stored in the wheel, however. When the magnet gets to the position where it is directly above the iron core of the Main Coil, a number of things happen. First of all, the iron reaches its maximum level of magnetization, which has been rising steadily as the magnet approached. This "change of magnetic flux" is what has been inducing the current in the Trigger Coil loop. So, when the magnetization reaches its peak, the "change" of magnetic flux stops, and therefore, the current flowing in the Trigger Coil loop stops, as well. At this point, the magnet on the wheel has magnetized the iron in the Main Coil so that it is "attracted" to it. That means that there is an induced magnetic field in the iron with a South Pole facing the wheel and a North Pole facing down.

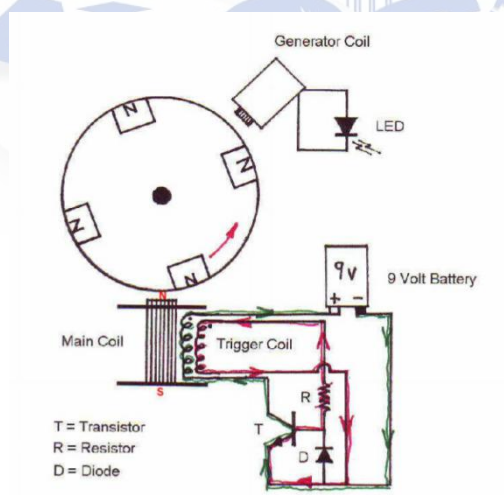

Fig 4.1.4

Now, the action really starts. The magnet on the wheel has been attracted to the iron and has stored some momentum, so it slips passed the alignment point with the iron core. Just as it does this, the magnetic field in the iron starts to drop, and that "change of magnetic flux" induces a current flow in the Trigger Coil loop that is in the opposite direction of what it was

before, indicated by the RED ARROWS. This event now activates the Transistor to turn ON, causing a flow of current from the 9 volt battery to flow through the Main Coil, indicated by the GREEN ARROWS. The current from the battery now forces the magnetic field in the iron to

reverse, so that its North Pole is now facing the wheel. This North Pole from the Main Coil now pushes the North Pole of the magnet on the wheel away, re-enforcing its established direction of rotation. This process continues until the iron core of the Main Coil reaches its maximum magnetization, based on the current flow from the 9 volt battery. At that instant, there is no more "change of magnetic flux" and so the induced current flowing in the Trigger Coil loop stops. This abruptly shuts off the Transistor, which in turn, stops supporting the magnetic field in the Main Coil, and so, the magnetic field must collapse and induce a current in the Trigger Coil, as indicated below by the GREEN ARROWS.

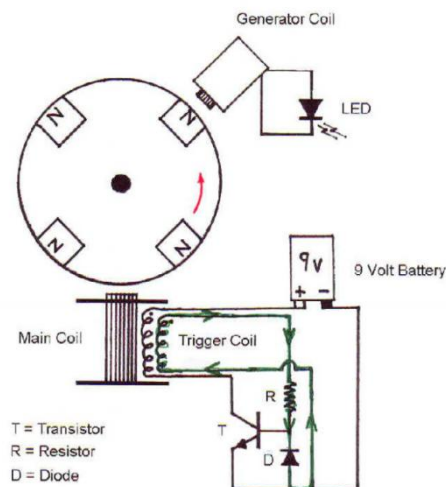

Fig 4.1.5

Meanwhile, the other magnet is approaching the generator coil, and is also being attracted to the small amount of iron there. As that magnet slips past the generator coil, a current is induced that lights up the LED for a single flash. As the rotor speeds up and these flashes happen more often, the LED appears to be ON all of the time.

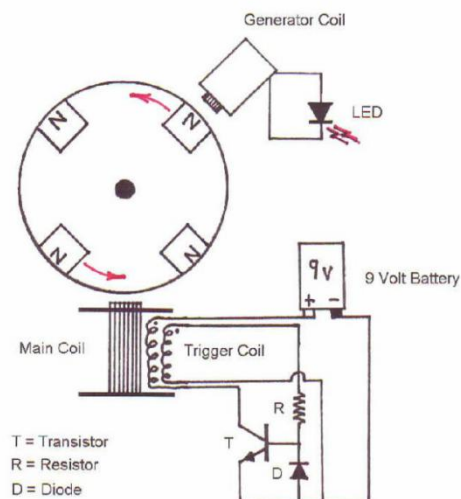



Fig 4.1.6

At this point in the diagram, the cycle is about to begin again, but this is NOT the end of the explanation of the operation of this machine. Even though most "self-respecting" electrical engineers will be quite pleased to believe that everything has been explained already, the problem is that if this was all that was taking place, the demonstration would run for about 6 hours on the 9 volt battery. This is what the science teachers thought, and why they were confused when it ran for closer to 5 days!

So, the machine continues to run because the battery is being recharged by a process that has NOT been explained yet. Granted, everything explained so far IS HAPPENING and can be measured on test equipment. But there is ONE MORE thing that is happening that is much more difficult to quantify, and this is it.

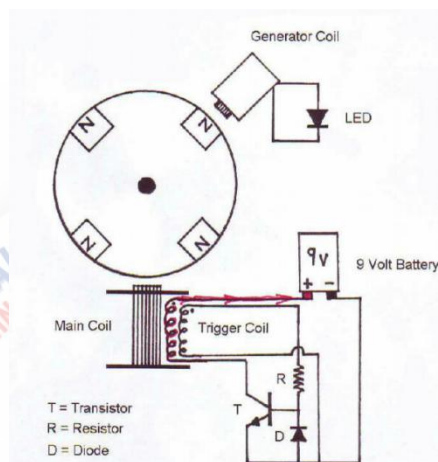

Fig 4.1.7

When the transistor turns OFF, and even before the current starts to flow in the trigger winding to dissipate the energy of the collapsing magnetic field, a high voltage spike, consisting of a longitudinal wave of pure potential, travels from the Main Coil winding back to the positive terminal of the 9 volt battery along one wire. The event is over in a few microseconds, but its effect on the battery is profound.

It temporarily reverses the flow of the heavier ions in the battery, which apparently slows the average "discharge rate" of the battery by up to 95%! This allows the battery to run the "toy demonstration" for a much longer time than the battery normally would.

This phenomenon, first reported by Nikola Tesla in the 1890s, is called "Radiant Energy" and its appearance demonstrates aspects of electrical science that few researchers have understood. Lucky for us, John Bedini spent 20 years experimenting and teaching himself about this process until he understood it so well he could teach it to a 10 year old school girl.

## 4.2 Optimizing Energy Recovery

This process works fairly well at this size and with these components. But when you start making the Main Coil larger, the voltage spike event starts becoming much more difficult to manage. Instead of simply spiking the battery, it also tends to start burning out the transistor. In order to allow for these conditions and make larger models, the following changes to the basic circuit must be made.

The first change is to switch from the little 9 volt battery to a more powerful 12 volt, rechargeable battery.

The next change is to ADD a component that protects the transistor, as a safety precaution, in case the voltage spike is not directed to the proper place. That extra component, in this case, is a NEON LIGHT bulb that completes the circuit if the voltage rises to about 100 volts.

As you can see, the NEON LIGHT is placed directly across the output terminals of the transistor that is turning the coil ON and OFF from the battery. This way, when the transistor turns OFF, the voltage spike can create a temporary pathway back to the battery AFTER the voltage rises high enough to turn the NEON LIGHT ON. Otherwise, when the Neon Light is OFF, no circuit connection is being made.

The next change is to ADD a SECOND BATTERY to take best advantage of the Voltage Spike. You see, batteries don't really perform very well when they are being "charged" and "discharged" rapidly and repeatedly. So, the best way to take advantage of this is to RUN the machine from one battery, and to CHARGE a second battery with the voltage spikes.

By adding a second battery to the circuit, one battery can now Run the system and the second battery can now be CHARGED by the system at the same time. This allows both batteries to operate at their highest levels of efficiency.

The next change is to ADD the extra wire to connect the new Charge Battery, as well as a NEW, High Voltage DIODE to direct the voltage spikes to this second battery.

The first diode in the circuit is needed to conduct currents in the trigger coil loop around the transistor when they were produced in the reverse direction. The new Diode must block currents from the second battery from discharging through the Main Coil. But it must also direct the voltage spike FROM the Main Coil back to the second battery whenever the Main Coil is disconnected from the RUN Battery after the transistor turns OFF. To do this without burning out, this New Diode must be rated for HIGHER VOLTAGES than the first diode.

So, this is the classic circuit for charging the second battery DIRECTLY from the discharges of the Main Coil. It works extremely well, but it also demonstrates an unusual phenomenon. Most Physicists and Electrical Engineers believe that all electricity is the same, and that electricity does NOT exhibit "quality" differences, only differences in quantity. In order to charge the second battery with a "quality" of electricity that is compatible with other methods of charging, one last modification must be made.

Here, we ADD a capacitor and a switch. Now, the voltage spikes from the Main Coil can be collected in the capacitor when the switch is open and periodically delivered to the battery when the switch is temporarily closed.

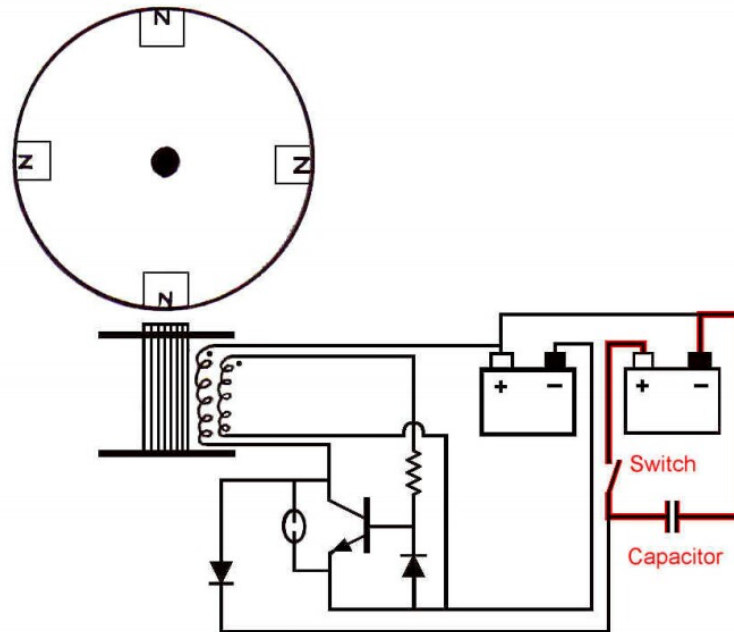

Fig 4.2.1



## 4.3 Two Modes Of Running

### 4.3.1 REPULSION MODE

The cycle starts when one of the magnets is closer to the coil than another and begins to be attracted to the iron in the core. The wheel will turn in either direction, and does NOT affect the operation of the circuit.

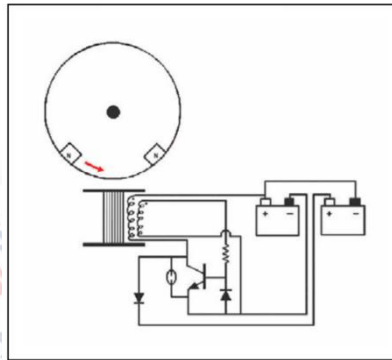

4.3.1.a)

As the magnet approaches the coil, it starts to magnetize the iron core and this "change in magnetic flux" begins to induce a current in the Trigger Winding in the direction of the RED ARROWS. Since this current is in the wrong direction to activate the Transistor, the Transistor stays OFF, and no power is used from the Battery while the magnet approaches the coil.

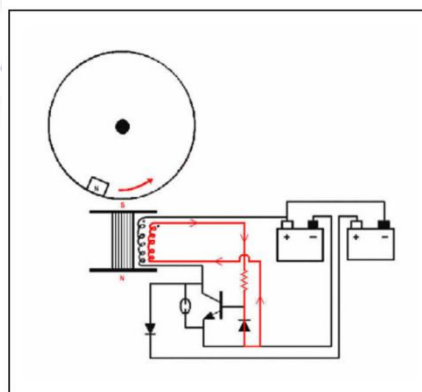

4.3.1.b)

When the magnet is directly over the top of the coil, the permanent magnet has induced its field into the coil core as much as it can. At this point, the "change in magnetic flux" that was inducing the current in the Trigger Winding stops rising, and so the current in the Trigger Coil also stops flowing.

The attraction of the magnet to the coil has produced some momentum on the wheel, so it slips past the top of the coil.

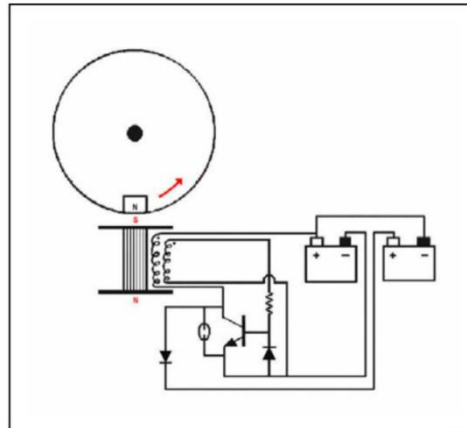

4.3.1.c)

As this happens, the magnetic flux in the coil core starts to drop, and so it induces a current in the Trigger Coil in the opposite direction. This turns ON the Transistor and allows current from the Battery to flow through the Main Coil, as show by the GREEN ARROWS. This current from the Battery now reverses the magnetic field in the coil core and produces a "repulsion force" on the magnet on the Wheel, re-enforcing its direction of rotation.

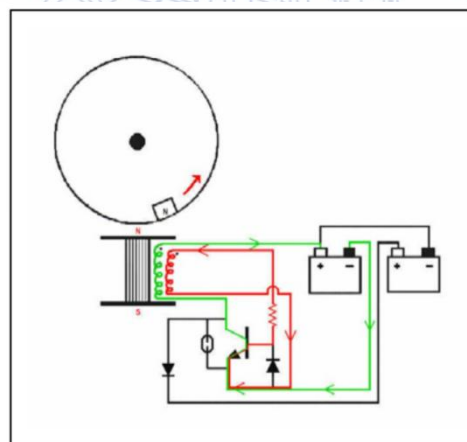

4.3.1.d)

As soon as the magnetic field reaches its maximum strength, based on the current delivered from the Battery through the Main Coil, the "change in magnetic flux" in the coil core stops inducing a current in the Trigger coil, and the Transistor shuts OFF. As soon as the Transistor shuts OFF, the magnetic field collapses, and this rapid change of magnetic flux induces a current in the Main Coil that discharges its energy into the Second Battery.

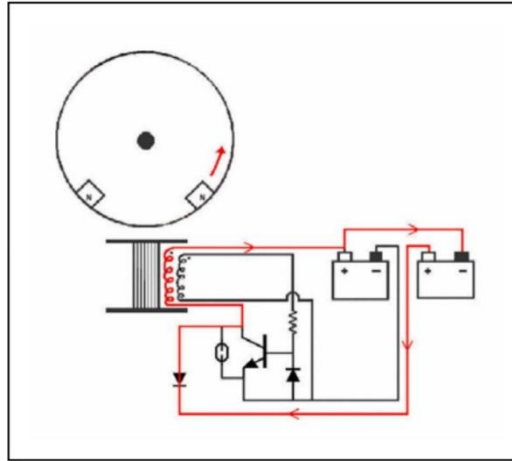

4.3.1.e)

So, this is the basic operation of the "Repulsion Mode" for the machine, and the general method of operation that has been taught for the last 8 years. In that time, the problem has been that most models built by people have not produced the same level of results that John's early models produced. When everything was looked at again carefully, it was finally noticed that the machines that produced the best results all had the "counter-clockwise" coils. We decided to see if any of the experimenters would report the discovery from their own experiments. Only a few experimenter's reported finding this in the forums, but no one else seemed to notice.



### 4.3.2 ATTRACTION MODE

This method of running the machine is identical to the Repulsion Mode except that the Coil is wound in the opposite direction. So, the circuit is the same and all of the magnets on the Wheel have their North Pole facing out.

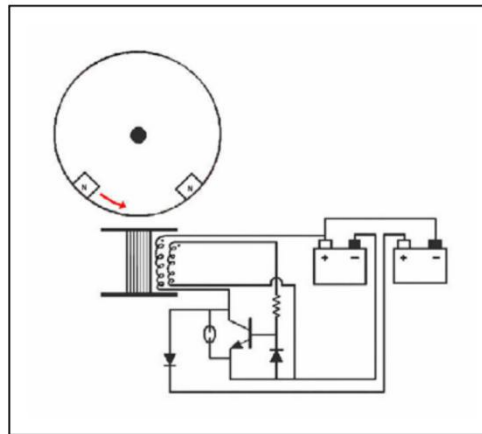

4.3.2.a)

The process starts the same way, when one magnet gets closer to the coil than another. This produces an attraction force on the Wheel. Like before, this approaching magnet induces a magnetic field in the coil core. But now, with the coil wrapped in the opposite direction, this induces a current in the Trigger Coil that turns the Transistor ON immediately.

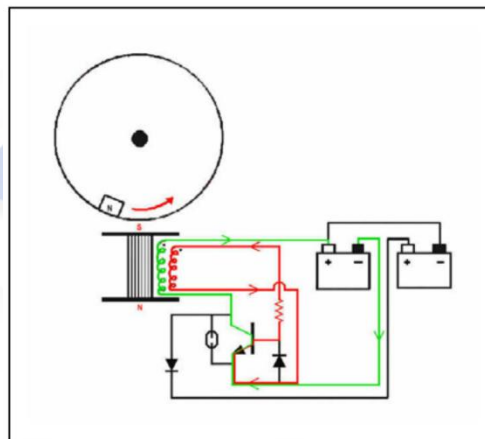

4.3.2.b)

Now, when the current flows from the Battery to the Main Coil, it produces a South Pole at the top, and this reinforces the induced field and makes the South Pole of the coil even stronger. This attracts the North Pole magnet on the Wheel with a much stronger force, while also re-enforcing the current flow in the Trigger Winding, keeping the Transistor ON.

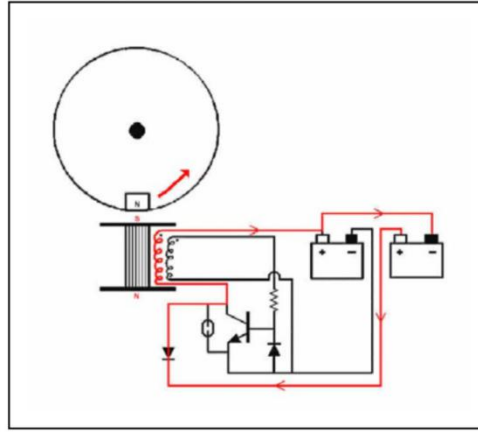

4.3.2.c)

When the magnet on the wheel arrives at the top of the coil, the magnetic flux stops changing, the Trigger Coil shuts the Transistor OFF, and the Main Coil discharges into the second Battery.

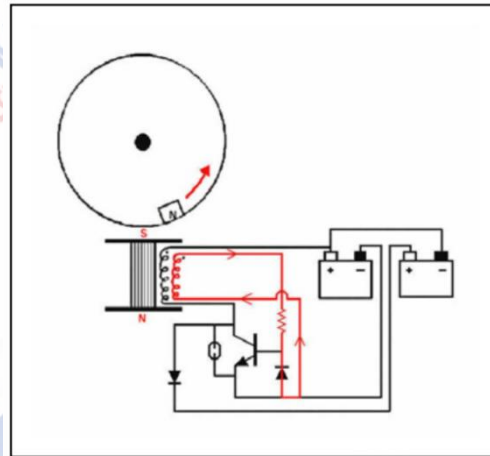

4.3.2.d)

With the collapse of the magnetic field in the Main Coil, the North Pole of the magnet on the wheel is attracted to the coil much less, and so it proceeds out of the field with all of the stored momentum it accumulated during the attraction period.



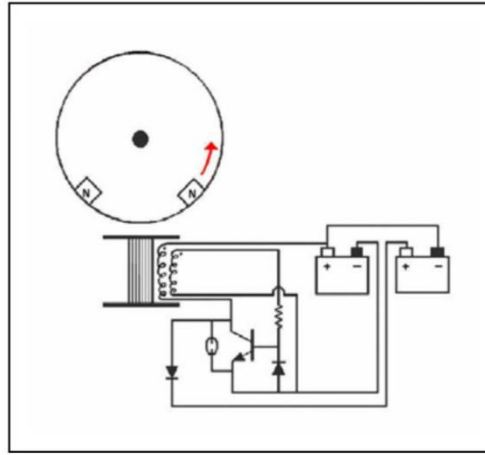

4.3.2.e)

As the magnet on the Wheel continues to move away, eventually, the combined voltage produced in the Main Coil and the Trigger Coil drops below the level necessary to recover the energy to the second Battery, at which point the last bit of discharge is dissipated in the Trigger Winding.

The magnet then proceeds to the point where the process begins again.

There are a number of reasons why the Attraction Mode works slightly more efficiently than the Repulsion Mode.

1. In the Repulsion Mode, energy from the Battery is used to reverse the magnetic field in the Main Coil. This amount of energy cannot be recovered when the magnetic field collapses. Since the magnetic field never reverses in the Attraction Mode, this loss of energy does not occur.
2. In the Attraction Mode, the mechanical force applied to the Wheel is the highest just before the Transistor turns OFF. In the Repulsion Mode, the mechanical force applied to the Wheel is the lowest just before the Transistor turns OFF. Therefore, the Attraction Mode makes better use of the full current moving through the Main Coil to produce mechanical energy on the Wheel.

## 4.4 Electronic Components Required

There are nine different parts used in the circuit they are:

### 1. a Battery(12 volts)

**The Battery** is the source of electric power used by the circuit. While the original Bedini SG built by Shawnee Baughman used a small 9 volt alkaline battery, all of the models you will be working with will use a rechargeable lead-acid type of battery. These can be sealed, like a "gel-cell" battery, or the more typical type of openable cell batteries, like you may use in your automobile. We recommend that you use the lead-acid type of battery that has openable cells. The reason for choosing a battery like this is that they are more difficult to damage when you are learning experimental charging methods. They are also relatively inexpensive and can run your experimental energizer for between 12 and 24 hours at a time.

### 2. a Coil (Bifilar coil)

**The Coil** is the component in the circuit that produces a magnetic field when electricity flows through it. It consists of a plastic coil frame, sometimes called a "spool", one or more lengths of wire wrapped around this frame, and a material in the center of the frame to channel the magnetic field.

The coil frame is quite often in the shape of a "spool" with an open center section. This way, wire may be wound around the outside of the spool and held together by the plastic disks on each end, while the open center may be filled with a material that will channel the magnetic field. Here we see an image of a coil illustrating these features.

### 3. a Transistor( MJL21194-G )

**The Transistor** is a "semi-conductor" device that has a complex function to regulate the circuit. There are thousands of different types of transistors that perform hundreds of different kinds of functions in different circuits. The kind shown here, and the kind we will use for this project, is an NPN Bi-polar Junction Transistor.

In use, the transistor in this circuit will be acting like an ON/OFF switch. The Emitter is connected to the Negative of the Battery, the Collector is connected to the Main Coil, and the Base is connected to the part of the circuit that tells the transistor when to turn ON and when to turn OFF.

### 4. a Resistor( 470 Ohm, 1 Watt )

**The Resistor** is a passive component that regulates how much electric current moves through that part of the circuit. It has two connections fitted to either end of a cylindrical body. It can be hooked up to the circuit in either direction.

#### 5. a Diode ( 1N4007 )

**The Diode** is a component that only allows electricity to flow ONE WAY in the circuit. It acts like a valve that is open to electricity flowing in one direction, but if it tries to go backwards, the valve shuts and prevents the electricity from coming back. It does this with no moving parts, using a special semi-conductor junction, like ½ of a transistor.

#### 6. a Capacitor ( 1 F, 20 volts)

**The Capacitor** is a component that stores electricity. Whereas a battery stores electricity in a chemical form, the capacitor stores the electricity as an electrical stress across a material called the "dielectric." Because no chemical changes have to happen for electricity to move into or out of a capacitor, it means that a capacitor can be charged and discharged very quickly, almost instantaneously, in fact.

#### 7. a LED

**The LED (Light Emitting Diode)** is a special diode that works as a light source. Actually, most semi-conductor junctions produce some light when they operate, but LEDs are designed to maximize the light producing function.

#### 8. a Neon Light

**The Neon Light** is a specialty lighting device where two electrodes are placed near each other in an enclosed space that contains a small amount of Neon gas at very low pressure. It usually takes about 100 volts to make a neon bulb light up.

#### 9. a Switch(Electronic switch)

**The Switch** is any device that allows a temporary contact between two sections of a circuit. In the Bedini SG Project, the Switch is used to discharge the Capacitor into the Battery after it has been charged to a certain level by the discharges of the Main Coil.

## Chapter 5

### Construction

The unit consists of a base and Frame that holds all of the other parts in place, a Wheel with 24 magnets mounted on it that is free to turn with low friction, a Coil with 8 separate strands of wire on it, and a Circuit that consists of 7 transistors, 7 resistors, 14 diodes, 7 neon bulbs, and 2 batteries.

The wheel is a 22" bicycle wheel used for the front of the bike. On the periphery of wheel 24 (1" x 2" x .5") permanent magnets made from Ceramic #8 material are provided.

The coil is made from a plastic spool that is 3.25 inches high, 3.5 inches in diameter, with a central cylinder of .75 inches in diameter. This spool is wound with 8 wires that are twisted together. 7 of these wires are #20 magnet wire 130 feet long, and the 8th wire is #23 magnet wire 130 feet long. 4. The circuit consists of 7 MJL21194-G transistors; 7 470 Ohm, 1 Watt resistors; 14 1N4007 Diodes; and 7 NE-2 neon lights.

#### 5.1 Wheel Construction

The Wheel is made from a bicycle wheel rim. The exact dimension of the wheel rim is 22 inches, measuring from the outside of the rim on one side to the outside of the rim on the other side. 24 permanent magnets, measuring 1 x 2 x .5 inches, made from Ceramic #8 material, are mounted around the rim with a uniform 3 inch spacing between them. All magnets should have the NORTH POLE facing outward. A layer of STRAPPING TAPE wounded around the entire wheel, to prevent any magnet from flying off during operation. The clearance between the magnets and the top of the Coil is about  $\frac{1}{8}$  of an inch.

## 5.2 Coil Construction

The Coil consists of 8 strands of wire that are each 130 feet long 7 strands of #20 wire and 1 strand of #23 wire. The next operation involves filling the core of the spool with the iron "welding rod" sections. These are 1/16th inch diameter R45 mild steel welding rods, cut to 4½ inch lengths. We used around 150 of them.

## 5.3 Electronic Circuit

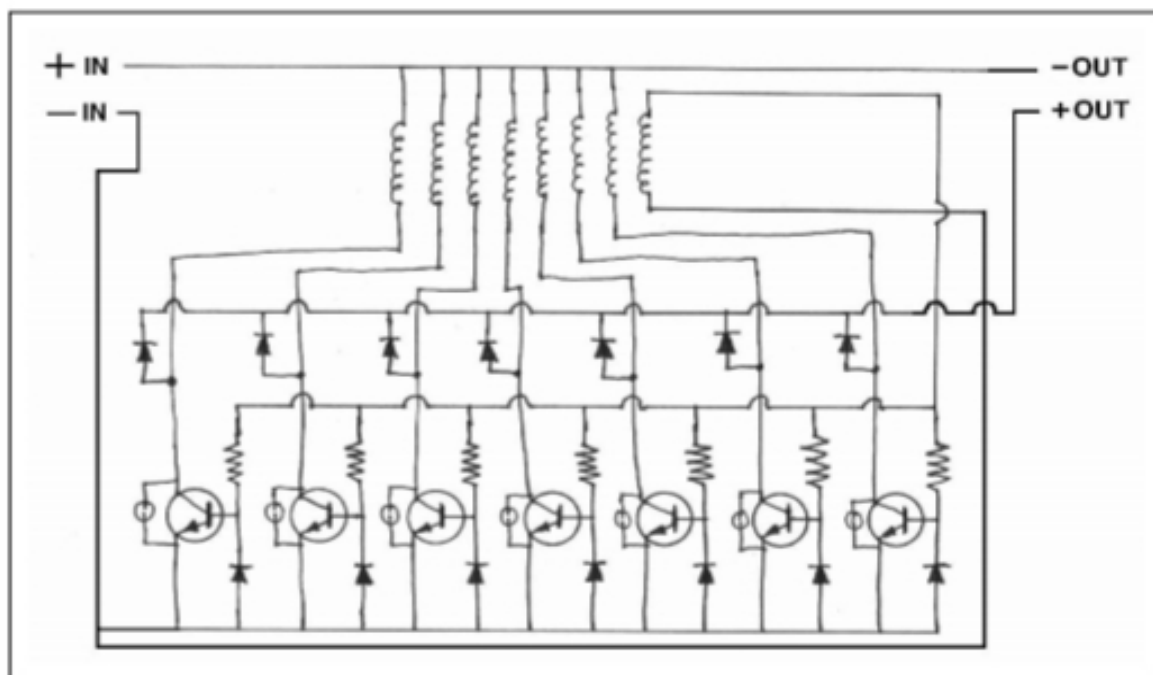

5.3.1 Electronic Circuit

The Circuit consists of the electronic components wired together to control what is happening at the coil. All of the schematic diagrams you have seen so far show a single Main Coil and a single Trigger Coil. Obviously, we just wound a coil with 8 wires on it, so something is different. What is different is that the Bicycle Wheel Energizer uses a coil that has 7 Main Coil windings on it, along with a single Trigger Coil winding.

## Chapter 6

### Advantages & Applications

#### 6.1 Advantages

- It provides free of cost energy.
- It runs perpetually.
- It reduces the carbon footprints.
- it reduces pollution and curbs global warming.
- Hugely advantageous in remote areas and uplifting the rural areas.

#### 6.2 Application and Future Scope

- Our project finds in application in the remote areas where electricity is not available.
- It can also be tremendously useful in military applications to provide electricity in remote adverse areas.
- It provides free of cost energy.
- A larger unit developed can be used as an independent grid .

## Chapter 7

### Conclusion

At a time where there is growing importance of energy conservation and the depleting energy resources.

Development of free energy devices would serve as a much easier and better alternative to the depleting resources.

So it's high time to switch from conventional energy generation to free energy generation.

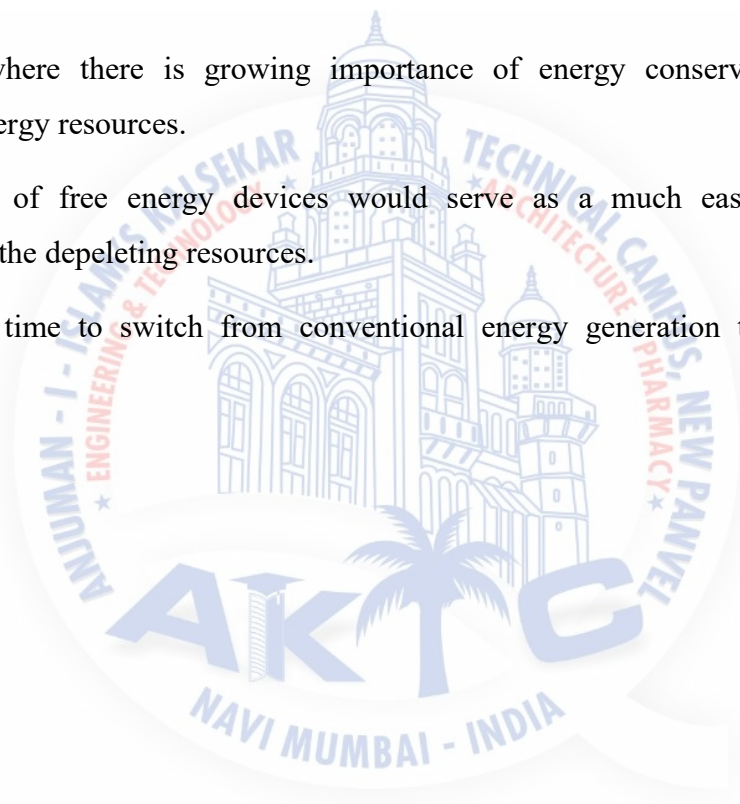

## Chapter 8

### References

- Bedini's free energy generator handbook.
- US PATENT-6392370
- US PATENT-6545444
- US PATENT-6677730
- US PATENT-7990110
- ATTRACTIONS OF MAGNETISM-JEAN MANNING
- [www.bedinisg.com](http://www.bedinisg.com)

